

Honeywell

VisionPRO[®] 8000 with Wi-Fi[®]

PRODUCT DATA



APPLICATION

The VisionPRO[®] 8000 with Wi-Fi features an effortless, 7-Day programmable touchscreen thermostat that provides control of temperature and one of the following: humidification, dehumidification, or ventilation. Up to 3 Heat/2 Cool heat pump systems or up to 2 Heat/2 Cool conventional systems are supported in residential and commercial applications.

FEATURES

- **Thermostat acquires weather data through either a wired sensor or an Internet connection, making for a truly universal installation.**
- **U1 Terminals**
One set of universal outputs that are configurable for one IAQ product, such as a Humidifier, Dehumidifier or Ventilator.
- **Thermostat S1, S1**
Configurable S1 Terminals can be configured for a wired indoor, wired outdoor, or discharge air sensor.
- **On-board Humidity sensor**
- **Customizable Service Reminders**
Set up to 10 service reminders. Choose from the pre-set options or customize your own. Reminders can be based on date or the outdoor temperature.
- **Selectable for Residential and Light Commercial Applications**
One thermostat does it all to meet the needs of Residential and Light Commercial applications. Simply select Residential or Commercial during the installer setup. If Commercial is selected, the thermostat will use commercial language, meet building codes and offer 365 day holiday scheduling.



33-00096-03

CONTENTS

Application	1	Ventilation	67
Ordering Information	2	Set up Ventilation	68
Specifications	3	IAQ Reminders	72
System Installation	5	Customizable Reminders	72
When Installing this Product...	5	Commercial Features	77
Wiring 24 Vac Common	6	Ramp Rates (Commercial Use)	80
Selecting Discharge Air Temperature Sensor		Economizer and Time of Day (TOD) Operation	80
Mounting Locations	6	Pre-Occupancy Purge	81
Selecting Discharge Air Temperature Sensor Mounting		Wired Indoor Sensors	81
Locations	6	Wiring	84
Selecting Thermostat Location	8	Wiring IAQ Equipment or a Heat/Cool Stage to the	
Installing Wallplate	8	Universal Terminals	86
Make Changes to Installer Setup	10	Wiring Economizer Control	87
Installer Setup (ISU) Table.	11	Wiring C7089U1006 Outdoor Sensor	88
Connect to Wi-Fi® Network	36	Wiring guide — Wired Indoor Sensors	89
Installer Tests	38	Troubleshooting	90
Using the Installer Test	38	Regulatory Information	91
Operation	39		
Setting the Time/Date	40		
Setting the Fan	40		
Setting System Mode	41		
Preset Energy-Saving Schedules	41		
Advanced Features	51		
Adaptive Intelligent Recovery (residential use only)	51		
Compressor Protection	51		
Staging Control	52		
Heat Pump and Backup Heat Operation 55			
Geothermal Radiant Heat	55		
Indoor Air Quality (IAQ) Control	57		
Humidification	57		
Set up Humidification	57		
Control Humidification Level	59		
Dehumidification - Residential	59		
Set up Dehumidification With Cooling System	60		
Set up Dehumidification With Whole House Dehumidifier	60		
Set up Dehumidification Away Mode	62		
Control Dehumidification Level	63		
Dehumidification - Commercial	63		
Set up Dehumidification With Cooling System	64		
Set up Dehumidification With Dehumidifier	65		
Control Dehumidification Level	66		

ORDERING INFORMATION

When purchasing replacement and modernization products from your TRADELINE® wholesaler or distributor, refer to the TRADELINE® Catalog or price sheets for complete ordering number. If you have additional questions, need further information, or would like to comment on our products or services, please write or phone:

1. Your local Honeywell Environmental and Combustion Controls Sales Office (check white pages of your phone directory).
2. Honeywell Customer Care
1985 Douglas Drive North
Golden Valley, Minnesota 55422-4386
3. <http://customer.honeywell.com> or <http://customer.honeywell.ca>

International Sales and Service Offices in all principal cities of the world. Manufacturing in Belgium, Canada, China, Czech Republic, Germany, Hungary, Italy, Mexico, Netherlands, United Kingdom, and United States.

SPECIFICATIONS

Thermostat Description:

Feature	Description
Powering method	<ul style="list-style-type: none"> Common wire
System types (up to 3 heat/2 cool heat pump and up to 2 heat/2 cool conventional)	<ul style="list-style-type: none"> Gas, oil or electric heat with air conditioning Warm air, hot water, high-efficiency furnaces, heat pumps, steam and gravity Cool only
Changeover	Manual or Auto changeover selectable
System setting	Em Heat-Heat-Off-Cool-Auto
Fan setting	Auto-On-Circ-Follow Schedule

Terminal	Voltage (50/60 Hz)	Max. Current Rating
W - O/B	18 to 30 VAC and 750 mVDC	1.00A
Y (cooling)	18 to 30 VAC	1.00A
G (fan)	18 to 30 VAC	0.50A
W2 - Aux 1 (heating)	18 to 30 VAC	0.60A
Y2 (cooling)	18 to 30 VAC	0.60A
A-L/A (Output)	18 to 30 VAC	1.00A
U1, U1, S1, S1	30 VAC max.	0.50A

Power Consumption of TH8321:

Backlight on: 1.48 VA

Backlight off: 0.88 VA

Temperature Setting Range:

Heating: 40 to 90 °F (4.5 to 32 °C).

Cooling: 50 to 99 °F (10 to 37 °C).

Temperature Sensor Accuracy:

± 1.5 F at 70 F (0.75 C at 21.0 C)

Humidification Setting Range:

10% to 60% RH.

Dehumidification Setting Range:

40% to 80% RH.

Humidity Display Range:

0% to 99%.

Humidity Sensor Accuracy:

± 5% RH from 30% to 50% RH at 75 F.

Cool Indication:

VisionPRO® 8000 with Wi-Fi® displays “Cool On” when the thermostat turns the cooling on.

Heat Indication:

VisionPRO® 8000 with Wi-Fi displays “Heat On” when the thermostat turns the heating on.

Auxiliary Heat Indication:

VisionPRO® 8000 with Wi-Fi displays “Aux Heat On” when the thermostat turns the auxiliary heat on.

Interstage Differential:

Comfort: The thermostat keeps the indoor temperature within 1 degree of the setpoint (droop less control). The thermostat turns on stage 2 when the capacity on stage 1 reaches 90%.

When the interstage differential is set to 1.0 or higher, the thermostat stages the equipment based on how far the indoor temperature is from the setpoint (ISU 303 to 309). See page 16 for more information.

Clock Accuracy: 1 minute per month at 77 °F (25 °C). ± 2 minutes per month over the operating ambient temperature range.

Mounting Means:

Thermostat mounts directly on the wall in the living space using mounting screws and anchors provided. Fits a horizontal 2 x 4 in. junction box.

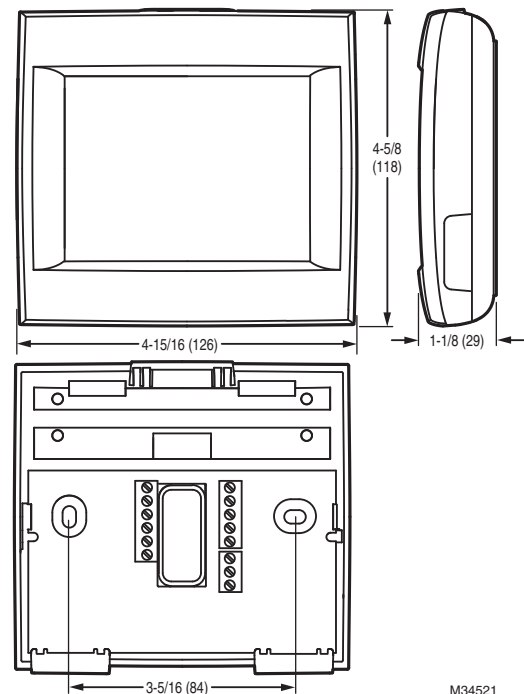

Fig. 1. Dimensions of thermostat in in. (mm).

Accessories

Product	Part Number
Wired Outdoor Sensor 10k ohm NTC	C7089U1006
Wired Wall-mount Indoor Sensor 10k ohm NTC	C7189U1005
Wired Flush-mount Indoor Sensor 20k ohm NTC	C7772A1004, C7772A1012
Wired Wall-mount Indoor Sensor 20k ohm NTC	TR21
Wired Wall-mount Indoor Sensor 10k ohm NTC	TR21-A
Cover Plate (covers marks left by old thermostats)	THP2400A1019
Wire Saver Module	THP9045A1023
Discharge Air Temperature Sensor	C7735

SYSTEM INSTALLATION

When Installing this Product...

1. Read these instructions carefully. Failure to follow the instructions can damage the product or cause a hazardous condition.
2. Check the ratings given in the instructions to make sure the product is suitable for your application.
3. Installer must be a trained, experienced service technician.
4. After completing installation, use these instructions to verify the product operation.

Finding Your Password (Date Code)

You will need the thermostat password to:

- Make changes to Installer Setup
- Perform an Installer Test
- Reset Thermostat to Factory Default Settings

The password (date code) is located on the back of the thermostat (see Fig. 2)

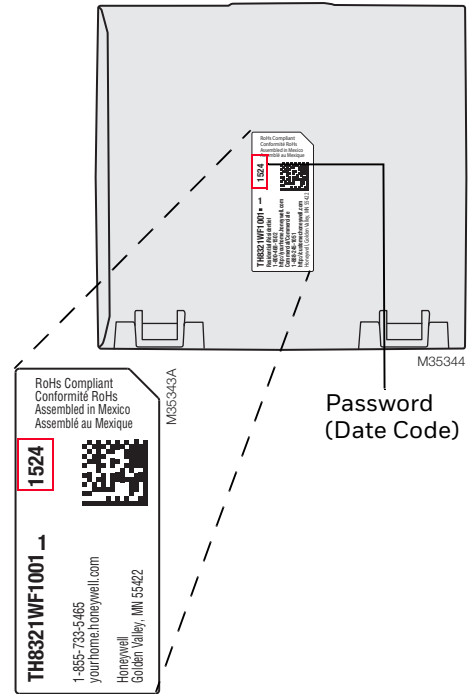

Fig. 2. Finding thermostat password.

You can also find the password (date code) by pressing MENU, selecting Dealer Information and then scrolling down to see the Date Code.

INSTALLATION

Model Numbering	TH8321
Stages	3H/2C HP 2H/2C CONV
Residential or Commercial	✓
Powered - C Wire (wire saver compatible)	✓
Onboard Humidity Sensor	✓
Number of Universal Relays	1
Number of Universal Sensor Inputs	1
Economizer / TOD Output	✓

Wiring 24 Vac Common

- Single-Transformer System—Connect the common side of the transformer to the C screw terminal of the thermostat. Leave the metal jumper wires in place between R and RC.
- Two-Transformer System—Connect the common side of the cooling transformer to the C screw terminal of the thermostat. Remove the metal jumper wire between R and RC. Connect the hot side of heating transformer to R and connect the hot side of cooling transformer to RC.

Selecting Discharge Air Temperature Sensor Mounting Locations

Refer to the guidelines below and Fig. 3–7 for mounting locations of the Discharge Air Temperature Sensor.

Selecting Discharge Air Temperature Sensor Mounting Location

1. Mount the Discharge Air Temperature Sensor on the supply duct in a location where the air is mixed well. Mount the Discharge Air Temperature Sensor out of sight of the A-Coil/Heat Exchanger when possible. See Fig. 3.
2. When possible, mount the Discharge Air Temperature Sensor upstream of a Steam Humidifier, a Fan Powered Humidifier or a Dehumidifier that is ducted to the supply. See Fig. 4–5.
3. If space does not allow a Discharge Air Temperature Sensor upstream of a Steam Humidifier or Fan Powered Humidifier, mount the Discharge Air Temperature Sensor downstream of the Humidifier. See Fig. 4.
4. If a Bypass Humidifier is installed, mount the Discharge Air Temperature Sensor downstream of the Bypass Humidifier. See Fig. 6–7.

Selecting Discharge Air Temperature Sensor Mounting Location

1. Install the Discharge Air Temperature Sensor on the duct in a location where the air is mixed well. See Fig. 3–7.

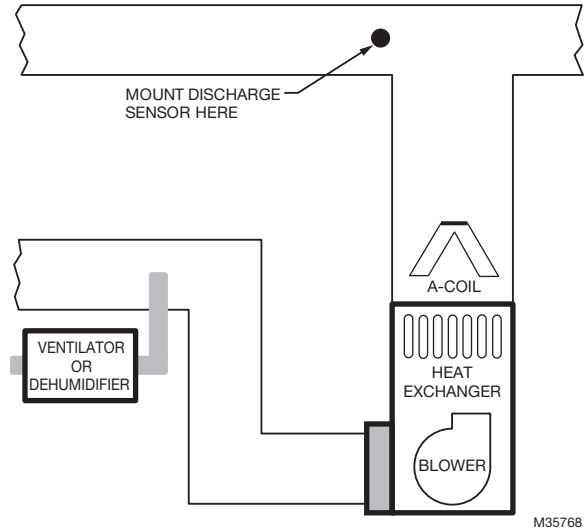

Fig. 3.

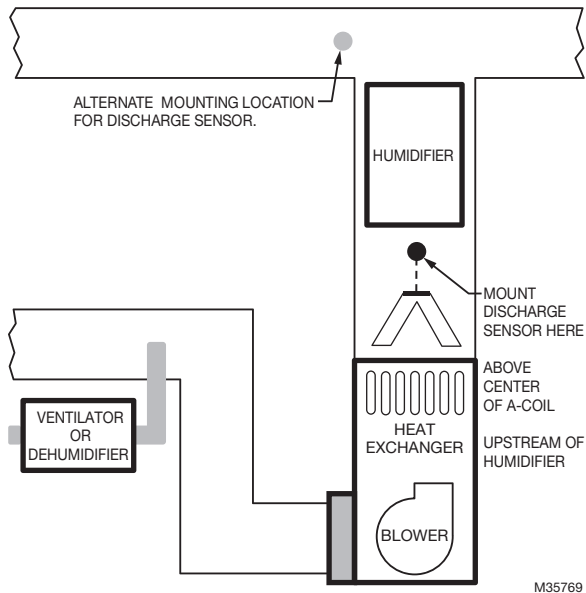

Fig. 4.

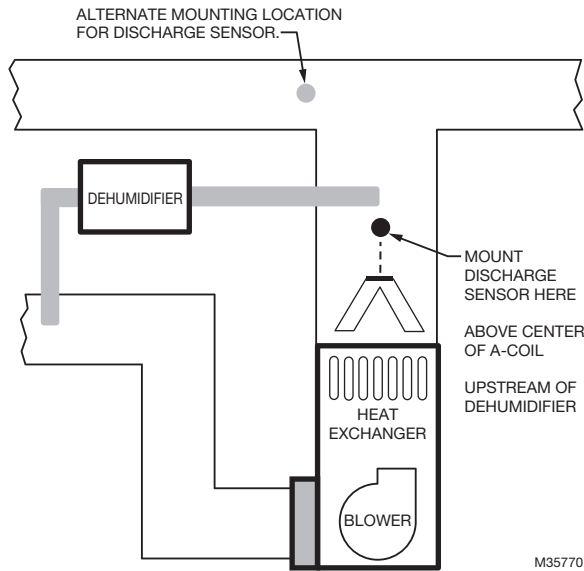

Fig. 5.

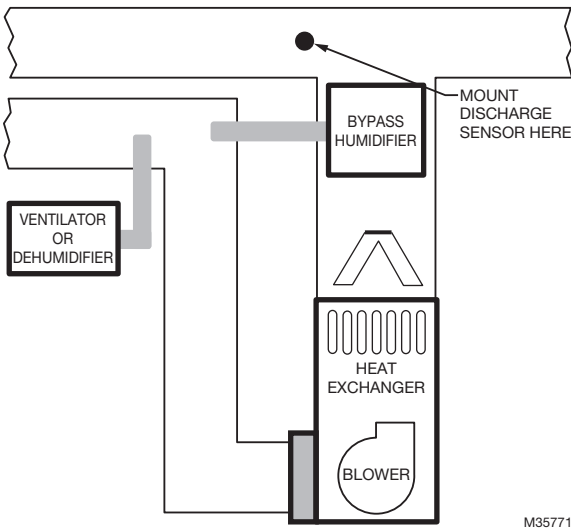

Fig. 6.

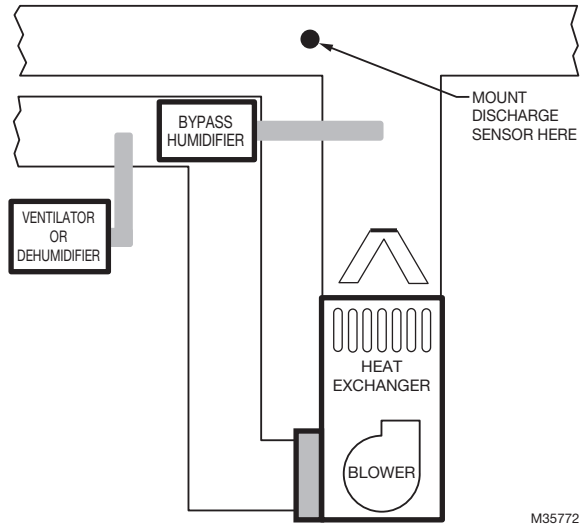

Fig. 7.

Installing Discharge Air Temperature Sensor

Use the following steps to mount the Discharge Sensor:

1. Attach plastic cover to the sensor probe.
2. Drill 1/4-inch hole for the sensor probe and mount it to the ductwork with enclosed screws (see Fig. 8).
3. Connect wires to S1 terminal at the thermostat.
4. Setup the S1 terminal in the Installer Setup at the thermostat.

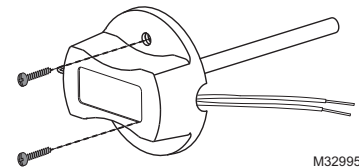

Fig. 8. Mounting Discharge Air Sensor.

Selecting Thermostat Location

Install the thermostat about 5 ft. (1.5m) above the floor in an area with good air circulation at average temperature. See Fig. 9.

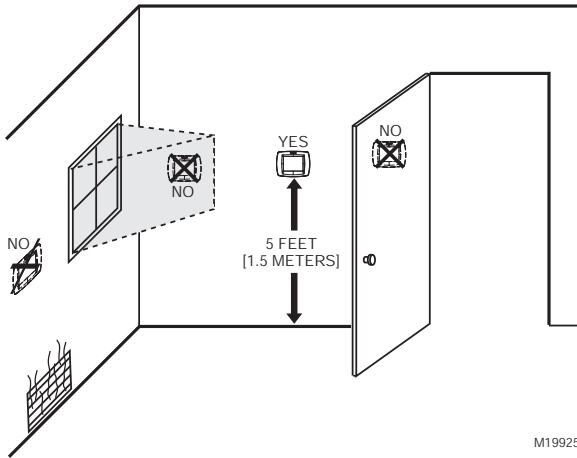

Fig. 9. Selecting thermostat location.

Do not install the thermostat where it can be affected by:

- Drafts or dead spots behind doors and in corners.
- Hot or cold air from ducts.
- Radiant heat from sun or appliances.
- Concealed pipes and chimneys.
- Unheated (uncooled) areas such as an outside wall behind the thermostat.

Installing Wallplate

CAUTION

Electrical Hazard.
Can cause electrical shock or equipment damage.
Disconnect power before wiring.

The thermostat can be mounted horizontally on the wall or on a 4 in. x 2 in. (101.6 mm x 50.8 mm) wiring box.

1. Press button on top and pull to remove the wallplate.

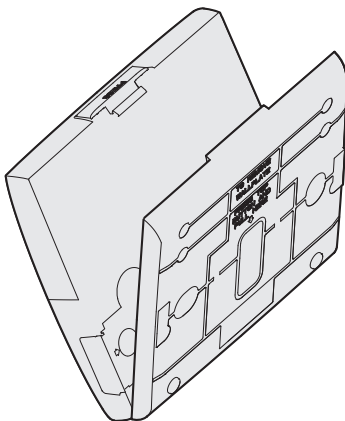

Fig. 10. Separate wallplate from thermostat.

2. Position and level the wallplate (for appearance only).
3. Use a pencil to mark the mounting holes.
4. Remove the wallplate from the wall and, if drywall, drill two 3/16-in. holes in the wall, as marked. For firmer material such as plaster, drill two 7/32-in. holes. Gently tap anchors (provided) into the drilled holes until flush with the wall.
5. Position the wallplate over the holes, pulling wires through the wiring opening. See Fig. 11.
6. Insert the mounting screws into the holes and tighten.

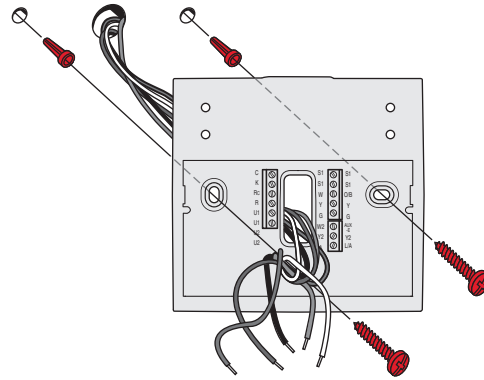

Fig. 11. Mounting wallplate.

7. Connect common side of transformer to C terminal.

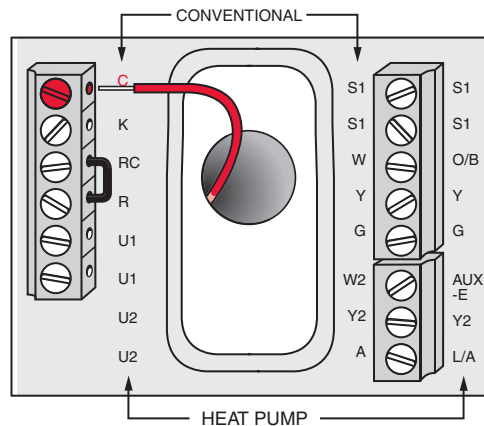

Fig. 12. Connecting C wire to terminal block.

Wiring the Thermostat

1. Refer to Fig. 13. See Table 9 on page 84 for terminal designations and “Wiring” beginning on page 84 for more information.
2. Turn on 24 VAC NOW.

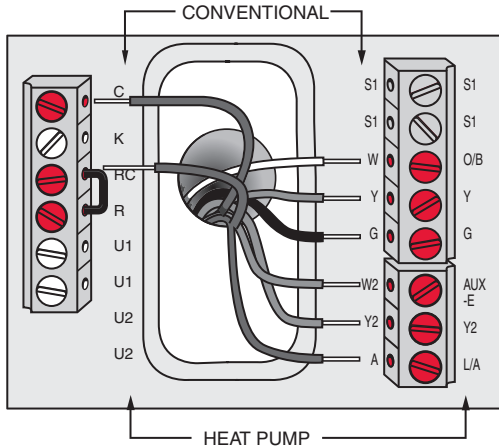

Fig. 13. Thermostat wired directly to equipment.

1. Power the thermostat using Rc and C terminals. Refer to Fig. 14.

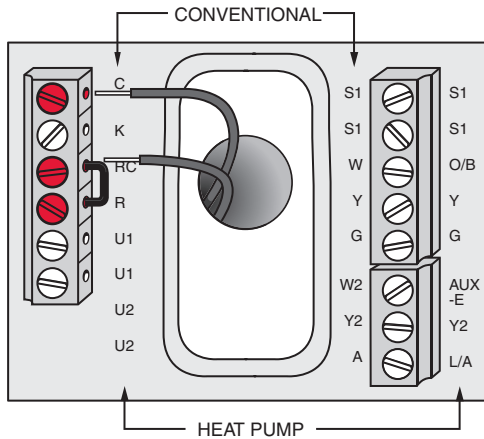

Fig. 14. Inserting wires in thermostat terminal block.

Mounting Thermostat on Wallplate

1. Align thermostat at bottom and snap into place as shown.

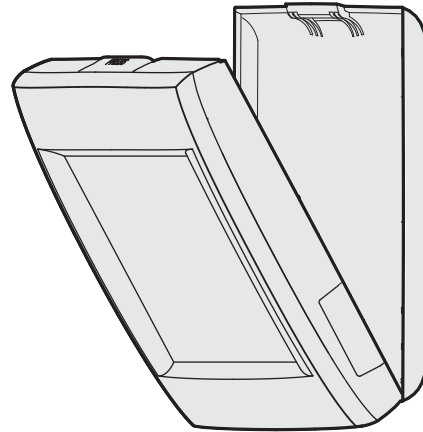

Fig. 15. Mount thermostat.

Finding Your Password (Date Code) to Access Installer Options

You need a password (Date Code) to access Installer Options. Installer Options allow you to:

- Make changes to the Installer Setup.
- Perform an Installer Test.
- Reset the thermostat to Factory Default settings.

The password (Date Code) is located on the back of the thermostat. It can also be found by following these steps:

1. Touch Menu.
2. Select Dealer Information.



MCR34022

Fig. 16.

3. Scroll down to see the Date Code.

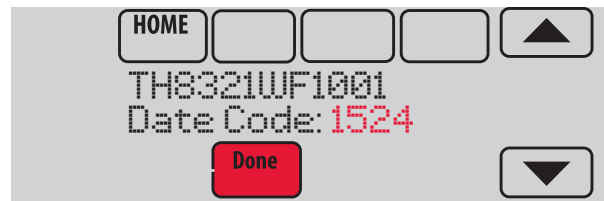

MCR35348

Fig. 17.

Thermostat Password (Date Code)

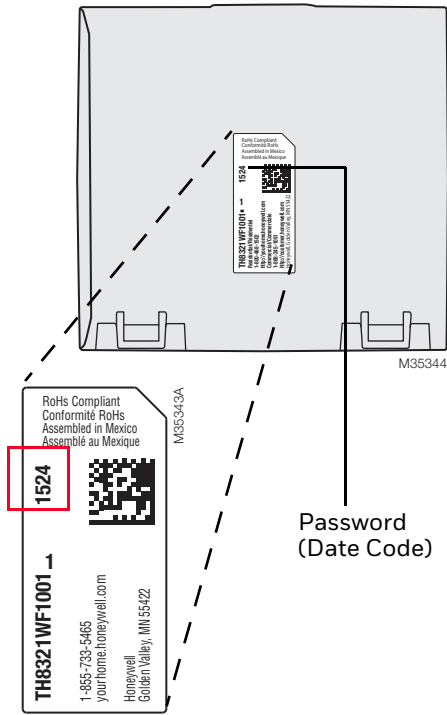

Fig. 18. Locate password.

The following options are available when you access Installer Options. For more information on each, press Help on the thermostat or see Table 1.



Fig. 19.

Table 1. Installer Options.

Menu Item	Description
Installer Setup	Select INSTALLER SETUP to set system settings one by one.
Installer Test	Select INSTALLER TEST to quickly determine if the heat, cool, fan and thermostat are operating properly. Minimum off timers are ignored during the test.
Reset To Defaults	Select RESET TO DEFAULTS to place all thermostat settings back to the factory settings.
Device Info	For Honeywell use only.

Make Changes to Installer Setup

1. Touch Menu.
2. Select Installer Options.

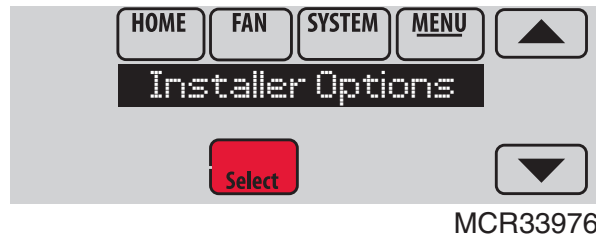

Fig. 20.

3. Enter password (date code) and touch Done. See "Finding Your Password (Date Code) to Access Installer Options" beginning on page 9 for more information.

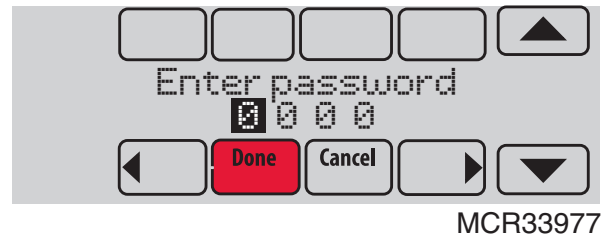

Fig. 21.

4. Select Installer Setup.



Fig. 22.

5. Follow prompts on the screen to select the desired setup options. See Table 2 for Installer Setup options.

Table 2. Installer Setup (ISU) Table.

ISU Number	Installer Setup Name	Settings	Default	Residential, Commercial or Both	Notes
101	Application	Residential Commercial	Residential	Both	
103	Thermostat Name	[Select Thermostat Name]	Thermostat	Both	The Web Interface displays the name of the thermostat that you enter on this screen.
104	Thermostat Type	Non-Programmable Programmable	Programmable	Both	
105	Temperature Scale	Fahrenheit Celsius	Fahrenheit	Both	
106	Outdoor Temp	Wired/Internet No	No	Both	Select Wired/Internet to indicate that you are going to connect a wired outdoor sensor or connect to the internet. This will allow you to configure settings prior to the Internet being connected. Select No if you are not going to connect to an outdoor sensor or the Internet.
200	Heating System	Conv. Forced Air Heat Pump Radiant Heat Other None (Cool Only)	Conv. Forced Air	Both	For Dual Fuel, choose Heat Pump.
201	Heating Equipment	Heat Pump: Air to Air Heat Pump Geothermal Geothermal Radiant	Air to Air Heat Pump	Both	This ISU is not displayed when ISU 200 Heating System is set to Conv. Forced Air, Radiant Heat, Other or None (Cool Only). See "Geothermal Radiant Heat" beginning on page 55.
202	Radiant Heat Stages	0 1 2		Both	Select the number of radiant heat stages.
203	Radiant Stage 1	None U1	Default varies based on previous selections	Both	This ISU is only displayed when ISU 201 Heating Equipment is Geothermal Radiant. Geothermal Radiant Heat must be wired to universal terminal U1. U1 is a normally open set of dry contacts. U1 requires power from the system transformer or a separate transformer.
205	Geo Forced Air	None Cooling Only Heating and Cooling	Heating and Cooling	Both	This thermostat has the capability of controlling Geothermal Radiant Heat, Geothermal Forced Air and Backup Heat. If this thermostat is not controlling the Geothermal Forced Air System, select None. This setting is typically used if the thermostat is only controlling Geothermal Radiant Heat. If this thermostat is using the Geothermal Forced Air System for cooling and not for heating, select Cooling Only. If this thermostat is using the Geothermal Forced Air System for both heating and cooling, select Heating and Cooling.
206	Reversing Valve	O (O/B on Cool) B (O/B on Heat)	O/B on Cool	Both	Only displayed if the equipment type is Air to Air Heat Pump, Geothermal or Geothermal Radiant.

Table 2. Installer Setup (ISU) Table. (Continued)

ISU Number	Installer Setup Name	Settings	Default	Residential, Commercial or Both	Notes
207	Cool Stages / Compressor Stages	0 1 2 3	1 if ISU 101 is Residential 2 if ISU 101 is Commercial	Both	Conventional: Cool Stage 3 is only available if ISU 101 is Commercial. Cool Stage 3 must be wired to the universal terminal (U1). Heat Pumps: Maximum of 2 Compressor Stages for heat pump systems.
202, 207	Heat / Radiant / Backup Heat Stages	1 - 3	Default is 1 stage if ISU 101 Application is Residential Default is 2 stages if ISU 101 Application is Commercial	Both	Maximum of 3 stages for conventional systems. Maximum of 3 stages for radiant heat. Maximum of 3 stages for Primary Heat. (Heating system, ISU 200 is set to "Other.") Maximum of 2 Backup Heat Stages for systems with more than 1 heating equipment type. NOTE: Depending on the application, the text displayed on the screen may show the specific heating equipment type.
208	Cool Stage 3	None U1	Default varies based on previous selections	Commercial	Cool Stage 3 is only available if ISU 101 is Commercial. Cool Stage 3 must be wired to the universal terminal (U1). U1 are normally open dry contacts when configured for a stage of Cool. U1 requires power from a system transformer or a separate transformer.
210	Heat Stage 3	None U1	Default varies based on previous selections	Both	Heat Stage 3 must be wired to the universal terminal (U1). U1 is a normally open dry contact when configured for a stage of Heat. U1 requires power from a system transformer or a separate transformer.
211	Fan Control in Heat	No Fan Equip Controls Fan Tstat Controls Fan	Equip Controls Fan	Both	No Fan is only displayed when ISU 201 Heating Equipment is Other.
212	Backup Heat Type	None Electric Gas/Oil	None	Both	This ISU is only displayed when ISU 200 Heating Equipment is Radiant Heat or Other. When ISU 200 Heating Equipment is Radiant Heat, the thermostat keeps the Radiant Heat on when it calls for Backup Heat. When ISU 200 Heating Equipment is Other, you can select how the backup operates. See ISU 215.
213	Backup Heat Stages	0 - 2	1	Both	This ISU is only displayed when a backup heat source is selected at ISU 212 Backup Heat Type. Maximum of 2 Backup Heat stages.

Table 2. Installer Setup (ISU) Table. (Continued)

ISU Number	Installer Setup Name	Settings	Default	Residential, Commercial or Both	Notes
214	Backup Heat Stg 2	None U1	Default varies based on previous selections	Both	The thermostat supports up to 2 backup heat stages. When there are 2 backup heat stages, backup heat stage #2 must be wired to U1. U1 is a normally open dry contact when configured for a stage of Heat. U1 requires power from a system transformer or a separate transformer.
215	Run Backup Heat with Primary	No Yes	No	Both	This ISU is only displayed when ISU 200 Heating Equipment is Other. When ISU 200 Heating Equipment is Other, you can select how the Backup Heat operates. The thermostat can be setup to keep the primary heat source on when it calls for Backup Heat or the thermostat can be setup to turn off the primary heat source when it calls for Backup Heat. When ISU 200 Heating Equipment is Radiant Heat, the thermostat keeps the Radiant Heat on when it calls for Backup Heat.
216	Backup Heat Fan	Equip Controls Fan Tstat Controls Fan	Tstat Controls Fan	Both	This ISU is only displayed for conventional systems when ISU 212 Backup Heat Type is Electric. Backup Heat Fan Operation automatically defaults to Equip Controls Fan when ISU 212 Backup Heat Type is Gas/Oil.
217	Backup Heat Stage 2	None U1	Default varies based on previous selections	Both	The thermostat can support up to 2 backup heat stages for heat pump applications. When there are 2 backup heat stages, backup heat stage 2 must be wired to U1. U1 is a normally open dry contact when configured for a stage of Heat. U1 requires power from a system transformer or a separate transformer.
218	Backup Heat Type	Electric Gas/Oil	Electric	Both	This ISU is only displayed when ISU 201 Heating Equipment is Air to Air Heat Pump, Geothermal or Geothermal Radiant and there is at least one stage of backup heat. See "Heat Pump and Backup Heat Operation" beginning on page 55.
219	External Fossil Fuel Kit	No Yes	No	Both	This ISU is only displayed when ISU 201 Heating Equipment is Air to Air Heat Pump, Geothermal or Geothermal Radiant and ISU 218 Backup Heat Type is Gas/Oil.
222	Economizer fault "FDD"	No Yes	No	Commercial	If your code requires that the thermostat display an alert when the economizer is sending a fault code, select "Yes". When this is done, the economizer will need to be wired as shown in Fig. 229 on page 87.
222	Economizer Wiring	T-stat terminal U1	T-stat terminal U1	Commercial	Only shown if "economizer fault FDD" is set to yes. This setting is to inform installer only. It is not adjustable. See economizer with fault wiring, Fig. 229 on page 87.

Table 2. Installer Setup (ISU) Table. (Continued)

ISU Number	Installer Setup Name	Settings	Default	Residential, Commercial or Both	Notes
222	A-L/A Terminal	None Time Of Day Economizer Heat Pump Fault Econ. Fault input	None or Econ. Fault input	Commercial	<p>This ISU is only displayed when ISU 101 Application is Commercial.</p> <p>Note: When the thermostat is setup for Residential, the L/A terminal operates as described under "Heat Pump Fault". The L/A terminal requires no setup for residential applications.</p> <p>None: The A-L/A terminal is not used.</p> <p>Time of Day: The A-L/A terminal is energized during Occupied periods and when the user overrides the temperature. The terminal is de-energized during Unoccupied periods and in Standby mode.</p> <p>Economizer: The thermostat controls an economizer module to provide ventilation during Occupied periods and free cooling when outdoor conditions are favorable. The A-L/A terminal is energized during Occupied periods and during a call for cooling in Unoccupied periods. See "Economizer and Time of Day (TOD) Operation" beginning on page 80.</p> <p>Notes: The economizer module determines when outdoor conditions are favorable for free cooling.</p> <p>Heat Pump Fault: When 24 volts is detected on the L/A terminal (compressor monitor), the thermostat displays a message to alert the user when the heat pump requires service. The L/A terminal sends a continuous output to a zone panel when the thermostat is set to Emergency Heat mode. The zone panel will not turn on the heat pump when a zone is set to Emergency Heat mode.</p> <p>Econ. Fault input: Only shown if "Economizer fault FDD" is set to "yes". Not adjustable.</p>
222	A-L/A terminal	Economizer fault		Commercial	<p>This ISU is only shown when the "Economizer fault FDD" is set to "yes". It is set for "economizer fault" and is not adjustable. It is meant to inform the installer that the A-L/A terminal needs to be wired to the economizer as shown in Fig. 229 on page 87.</p>
300	System Changeover	Manual Automatic	<p>Manual: if ISU 101 is Residential</p> <p>Automatic: if ISU 101 is Commercial</p>	Both	<p>Manual: The user must select heating or cooling as needed to maintain the desired indoor temperature.</p> <p>Automatic: The user has the option to select Auto for the system setting. In Auto mode, the thermostat controls heating and cooling equipment as needed to maintain the desired indoor temperature.</p>

Table 2. Installer Setup (ISU) Table. (Continued)

ISU Number	Installer Setup Name	Settings	Default	Residential, Commercial or Both	Notes
300	Auto Changeover Deadband	2° F to 9° F (in 1° F increments)	3° F	Both	<p>This ISU is only displayed when ISU 300 is set to Automatic.</p> <p>Deadband is the minimum separation between heat and cool settings when the thermostat is setup for Auto Changeover. For example, if the deadband is set to 3° F and the cool setpoint is 75° F, the warmest heat setpoint allowed would be 72° F. If the heat setpoint is adjusted above 72° F, it will automatically adjust the cooling setpoint higher to maintain the 3° F deadband.</p> <p>When ISU 907 or ISU 910 (Dehum Over Cooling Limit) is set to 1, 2, 3, 4 or 5 F, the thermostat will not show the full Deadband range. For example, if you set a Deadband of 3 F and an Over Cooling Limit of 2 F, the minimum Deadband that you can select will be 5 F. This prevents the heating system from turning on when the thermostat over cools to reach the dehumidification setting.</p>
301	Control Options	Basic Options Advanced Options	Basic Options	Both	<p>Basic Options: The Installer Setup displays basic temperature control options which include Backup Heat Droop, Backup Heat Upstage Timer, Outdoor Temperature Lockouts and Cycle Rate settings per stage.</p> <p>Note: Outdoor Temperature Lockouts only apply to Heat Pump applications.</p> <p>Advanced Options: The Installer Setup displays both Basic and Advanced Options. Advanced temperature control options include Finish With High Cool Stage, Finish With High Heat Stage, and Temperature Differential settings between all stages.</p>
302	Finish With High Cool Stage	No Yes	No	Both	<p>ISU 301 Control Options must be set to Advanced to view or adjust Finish With High Cool Stage.</p> <p>This ISU is only displayed when the thermostat is set for 2 or more cool stages.</p> <p>When set to Yes, this feature keeps the high stage of the cooling equipment running until the desired setpoint is reached.</p>
302	Finish With High Heat Stage	No Yes	No	Both	<p>ISU 301 Control Options must be set to Advanced to view or adjust Finish With High Heat Stage.</p> <p>This ISU is only displayed when the thermostat is set for 2 or more heat stages.</p> <p>When set to Yes, this feature keeps the high stage of the heating equipment running until the desired setpoint is reached.</p>

Table 2. Installer Setup (ISU) Table. (Continued)

ISU Number	Installer Setup Name	Settings	Default	Residential, Commercial or Both	Notes
303	Cool Differential Stage 2	Comfort 1.0° F to 3.5° F from setpoint (in 0.5° F increments)	Comfort	Both	<p>ISU 301 Control Options must be set to Advanced to view or adjust this ISU.</p> <p>This ISU is only displayed when the thermostat is set to 2 cool stages.</p> <p>The indoor temperature must rise to the selected differential setting before the thermostat turns on the stage of cooling. For example, if stage 2 is set to 2° F (1.0° C), the indoor temperature must be 2° F (1.0° C) away from the setpoint before stage 2 turns on. When set to Comfort, the thermostat uses the stage of cooling as needed to keep the indoor temperature within 1° F (0.5° C) degree of the setpoint.</p>
303	Cool Differential Stage 3	Comfort 1.0°F - 4.0°F from setpoint (in 0.5° F increments)	Comfort	Commercial	<p>ISU 301 Control Options must be set to Advanced to view or adjust this ISU.</p> <p>This ISU is only displayed when the thermostat is set to 3 cool stages.</p> <p>The indoor temperature must rise to the selected differential setting before the thermostat turns on the stage of cooling. For example, if stage 3 is set to 2° F (1.0° C), the indoor temperature must be 2° F (1.0° C) away from the setpoint before stage 3 turns on. When set to Comfort, the thermostat uses the stage of cooling as needed to keep the indoor temperature within 1° F (0.5° C) degree of the setpoint.</p>
305	Heat Differential Stage 2 Note: Depending on the application, the text displayed on the screen may show the specific heating equipment type	Comfort 1.0° F to 3.5° F from setpoint (in 0.5° F increments)	Comfort	Both	<p>ISU 301 Control Options must be set to Advanced to view or adjust this ISU.</p> <p>This ISU is only displayed for conventional systems that have 2 heat stages.</p> <p>The indoor temperature must drop to the selected differential setting before the thermostat will turn on the stage of heating. For example, if stage 2 is set to 2° F (1.0° C), the indoor temperature must be 2° F (1.0° C) away from the setpoint before stage 2 turns on. When set to Comfort, the thermostat will use the stage of heating as needed to keep the indoor temperature within 1° F (0.5° C) degree of the setpoint.</p>
305	Heat Differential Stage 3 Note: Depending on the application, the text displayed on the screen may show the specific heating equipment type	Comfort 1.0° F to 4.0° F from setpoint (in 0.5° F increments)	Comfort	Both	<p>ISU 301 Temperature Control Options must be set to Advanced to view or adjust this ISU.</p> <p>This ISU is only displayed for conventional systems that have 3 heat stages.</p> <p>The indoor temperature must drop to the selected differential setting before the thermostat will turn on the stage of heating. For example, if stage 3 is set to 2° F (1.0° C), the indoor temperature must be 2° F (1.0° C) away from the setpoint before stage 3 turns on. When set to Comfort, the thermostat will use the stage of heating as needed to keep the indoor temperature within 1° F (0.5° C) degree of the setpoint.</p>

Table 2. Installer Setup (ISU) Table. (Continued)

ISU Number	Installer Setup Name	Settings	Default	Residential, Commercial or Both	Notes
306	Compressor Heat Diff. Stage 1	Comfort 1.0° F to 4.0° F from setpoint (in 0.5° F increments)	Comfort	Both	<p>ISU 301 Control Options must be set to Advanced to view or adjust this ISU.</p> <p>This ISU is only displayed if ISU 201 Heating Equipment is Geothermal Radiant and ISU 205 Geo Forced Air is set to Heating and Cooling.</p> <p>The indoor temperature must drop to the selected differential setting before the thermostat will turn on the stage of heating. For example, if stage 1 is set to 2° F (1.0° C), the indoor temperature must be 2° F (1.0° C) away from the setpoint before stage 1 turns on. When set to Comfort, the thermostat will use the stage of heating as needed to keep the indoor temperature within 1° F (0.5° C) degree of the setpoint.</p>
306	Compressor Heat Diff. Stage 2	Comfort 1.0° F to 4.5° F from setpoint (in 0.5° F increments)	Comfort	Both	<p>ISU 301 Control Options must be set to Advanced to view or adjust this ISU.</p> <p>This ISU is only displayed if ISU 201 Heating Equipment is Air to Air Heat Pump, Geothermal or Geothermal Radiant and there are 2 compressor stages.</p> <p>The indoor temperature must drop to the selected differential setting before the thermostat will turn on the stage of heating. For example, if stage 2 is set to 2° F (1.0° C), the indoor temperature must be 2° F (1.0° C) away from the setpoint before stage 2 turns on. When set to Comfort, the thermostat will use the stage of heating as needed to keep the indoor temperature within 1° F (0.5° C) degree of the setpoint.</p>
308, 309	Backup Heat Droop Stage 1 Note: "Stage 1" is not displayed if there is only 1 stage of Backup Heat.	Comfort 2.0° F to 15.0° F from setpoint (in 0.5° F increments)	Comfort	Both	<p>A backup heat droop can be set on any system that has more than one heating equipment type.</p> <p>See "Backup Heat Droop" beginning on page 53.</p> <p>The Comfort setting is NOT available for Dual Fuel systems. For example, Heat Pumps with Gas Forced Air.</p>
308, 309	Backup Heat Droop Stage 2	Comfort 2.0° F to 15.5° F from setpoint (in 0.5° F increments)	Comfort	Both	<p>ISU 301 Control Options must be set to Advanced to view or adjust Backup Heat Droop Stage 2.</p> <p>This ISU is only displayed if there are 2 backup heat stages.</p> <p>The indoor temperature must drop to the selected droop setting before the thermostat will turn on backup heat stage 2. For example, if backup heat stage 2 is set to 2° F (1.0° C), the indoor temperature must be 2° F (1.0° C) away from the setpoint before backup heat stage 2 turns on. When set to Comfort, the thermostat will use backup heat stage 2 as needed to keep the indoor temperature within 1° F (0.5° C) degree of the setpoint.</p>

Table 2. Installer Setup (ISU) Table. (Continued)

ISU Number	Installer Setup Name	Settings	Default	Residential, Commercial or Both	Notes
311	Upstage Timer for Backup Heat	Off (30, 45, 60, 75, 90) minutes (2, 3, 4, 5, 6, 8, 10, 12, 14, 16) hours	Off	Both	The Backup Heat Upstage Timer starts when the highest stage of the previous heating equipment type turns on. Backup heat will be used (if needed) when the timer expires. See "Backup Heat Upstage Timer" beginning on page 54. This ISU is only displayed when Backup Heat Droop Stage 1 is set to 2 F or higher (ISU 308, 309).
312	Outdoor Lockout Heat Pump (Balance Point)	Off 5° F to 60° F (in 5° F increments)	Off (See Notes)	Both	ISU 312 Heat Pump Outdoor Lockout requires an outdoor sensor. Default is 40 F if ISU 201 Heating Equipment is Air to Air Heat Pump and ISU 218 Backup Heat Type is Gas/Oil. Default is Off if ISU 201 Heating Equipment is Air to Air Heat Pump and ISU 218 Backup Heat Type is Electric. Default is Off if ISU 201 Heating Equipment is Geothermal or Geothermal Radiant. Heat Pump Outdoor Lockout is optional for any type of heat pump (Air to Air Heat Pump, Geothermal Heat Pump or Geothermal Radiant Heat). See "Heat pump with outdoor temperature lockouts" beginning on page 55.
312	Outdoor Lockout Backup Heat	Off 5° F to 65° F (in 5° F increments)	Off	Both	ISU 312 Backup Heat Outdoor Temperature Lockout requires an outdoor sensor. This ISU is only displayed if ISU 201 Heating Equipment is Air to Air Heat Pump, Geothermal or Geothermal Radiant and ISU 219 External fossil fuel kit is set to No. See "Heat pump with outdoor temperature lockouts" beginning on page 55.
313	Radiant Cycles Per Hour Stage 1 Note: "Stage 1" is not displayed if there is only 1 stage of Radiant Heat.	1 to 12 CPH	3	Both	This ISU is only displayed when ISU 201 Heating Equipment is Geothermal Radiant. The thermostat automatically defaults to the recommended setting for Geothermal Radiant Heat (3 CPH). Cycle rate limits the maximum number of times the system can cycle in a 1 hour period measured at a 50% load. For example, when set to 3 CPH, at a 50% load, the most the system will cycle is 3 times per hour (10 minutes on, 10 minutes off). The system cycles less often when load conditions are less than or greater than a 50% load.

Table 2. Installer Setup (ISU) Table. (Continued)

ISU Number	Installer Setup Name	Settings	Default	Residential, Commercial or Both	Notes
314	Cool / Compressor Cycles Per Hour Stage 1 Note: "Stage 1" is not displayed if there is only 1 stage.	1 to 6 CPH	3	Both	This ISU is only displayed when ISU 207 Cool / Compressor Stages is set to 1 stage. Cycle rate limits the maximum number of times the system can cycle in a 1 hour period measured at a 50% load. For example, when set to 3 CPH, at a 50% load, the most the system will cycle is 3 times per hour (10 minutes on, 10 minutes off). The system cycles less often when load conditions are less than or greater than a 50% load.
314	Cool / Compressor Cycles Per Hour Stage 2	1 to 6 CPH	3	Both	This ISU is only displayed when ISU 207 Cool / Compressor Stages is set to 2 stages. Cycle rate limits the maximum number of times the system can cycle in a 1 hour period measured at a 50% load. For example, when set to 3 CPH, at a 50% load, the most the system will cycle is 3 times per hour (10 minutes on, 10 minutes off). The system cycles less often when load conditions are less than or greater than a 50% load.
314	Cool Cycles Per Hour Stage 3	1 to 6 CPH	3	Commercial	This ISU is only displayed when ISU 101 Application is set to Commercial and ISU 207 Cool Stages is set to 3 stages. Cycle rate limits the maximum number of times the system can cycle in a 1 hour period measured at a 50% load. For example, when set to 3 CPH, at a 50% load, the most the system will cycle is 3 times per hour (10 minutes on, 10 minutes off). The system cycles less often when load conditions are less than or greater than a 50% load.
315	Heat Cycles Per Hour Stage 1 Note: Depending on the application, the text displayed on the screen may show the specific heating equipment type. "Stage 1" is not displayed if there is only 1 stage.	1 to 12 CPH	Conv. Forced Air = 5 CPH Heat Pump = 3 CPH Radiant Heat = 3 CPH	Both	This ISU is only displayed when ISU 207 Heat Stages is set to 1 stage. Cycle rate limits the maximum number of times the system can cycle in a 1 hour period measured at a 50% load. For example, when set to 3 CPH, at a 50% load, the most the system will cycle is 3 times per hour (10 minutes on, 10 minutes off). The system cycles less often when load conditions are less than or greater than a 50% load. The recommended cycle rate settings are below for each heating equipment type: Standard Efficiency Gas Forced Air = 5 CPH High Efficiency Gas Forced Air = 3 CPH Oil Forced Air = 5 CPH Electric Forced Air = 9 CPH Hot Water Fan Coil = 3 CPH Hot Water Radiant Heat = 3 CPH Geothermal Radiant Heat = 3 CPH Steam = 1 CPH Gravity = 1 CPH

Table 2. Installer Setup (ISU) Table. (Continued)

ISU Number	Installer Setup Name	Settings	Default	Residential, Commercial or Both	Notes
315	Heat Cycles Per Hour Stage 2 Note: Depending on the application, the text displayed on the screen may show the specific heating equipment type.	1 to 12 CPH	Conv. Forced Air = 5 CPH Heat Pump = 3 CPH Radiant Heat = 3 CPH	Both	This ISU is only displayed when ISU 207 Heat Stages is set to 2 stages. Cycle rate limits the maximum number of times the system can cycle in a 1 hour period measured at a 50% load. For example, when set to 3 CPH, at a 50% load, the most the system will cycle is 3 times per hour (10 minutes on, 10 minutes off). The system cycles less often when load conditions are less than or greater than a 50% load. The recommended cycle rate settings are below for each heating equipment type: Standard Efficiency Gas Forced Air = 5 CPH High Efficiency Gas Forced Air = 3 CPH Oil Forced Air = 5 CPH Electric Forced Air = 9 CPH Hot Water Fan Coil = 3 CPH Hot Water Radiant Heat = 3 CPH Geothermal Radiant Heat = 3 CPH Steam = 1 CPH Gravity = 1 CPH
315	Heat Cycles Per Hour Stage 3 Note: Depending on the application, the text displayed on the screen may show the specific heating equipment type.	1 to 12 CPH	Conv. Forced Air = 5 CPH Heat Pump = 3 CPH Radiant Heat = 3 CPH	Both	This ISU is only displayed when ISU 207 Heat Stages is set to 3 stages. Cycle rate limits the maximum number of times the system can cycle in a 1 hour period measured at a 50% load. For example, when set to 3 CPH, at a 50% load, the most the system will cycle is 3 times per hour (10 minutes on, 10 minutes off). The system cycles less often when load conditions are less than or greater than a 50% load. The recommended cycle rate settings are below for each heating equipment type: Standard Efficiency Gas Forced Air = 5 CPH High Efficiency Gas Forced Air = 3 CPH Oil Forced Air = 5 CPH Electric Forced Air = 9 CPH Hot Water Fan Coil = 3 CPH Hot Water Radiant Heat = 3 CPH Geothermal Radiant Heat = 3 CPH Steam = 1 CPH Gravity = 1 CPH

Table 2. Installer Setup (ISU) Table. (Continued)

ISU Number	Installer Setup Name	Settings	Default	Residential, Commercial or Both	Notes
316	Backup Heat Cycles Per Hour Stage 1 Note: "Stage 1" is not displayed if there is only 1 stage.	1 to 12 CPH	Electric = 9 CPH Gas / Oil = 5 CPH	Both	This ISU is only displayed when ISU 207 or 213 Backup Heat Stages is set to 1 stage. Cycle rate limits the maximum number of times the system can cycle in a 1 hour period measured at a 50% load. For example, when set to 3 CPH, at a 50% load, the most the system will cycle is 3 times per hour (10 minutes on, 10 minutes off). The system cycles less often when load conditions are less than or greater than a 50% load. The recommended cycle rate settings are below for each heating equipment type: Standard Efficiency Gas Forced Air = 5 CPH High Efficiency Gas Forced Air = 3 CPH Oil Forced Air = 5 CPH Electric Forced Air = 9 CPH Hot Water Fan Coil = 3 CPH Hot Water Radiant Heat = 3 CPH Geothermal Radiant Heat = 3 CPH Steam = 1 CPH Gravity = 1 CPH
316	Backup Heat Cycles Per Hour Stage 2	1 to 12 CPH	Electric = 9 CPH Gas / Oil = 5 CPH	Both	This ISU is only displayed when ISU 207 or 213 Backup Heat Stages is set to 2 stages. Cycle rate limits the maximum number of times the system can cycle in a 1 hour period measured at a 50% load. For example, when set to 3 CPH, at a 50% load, the most the system will cycle is 3 times per hour (10 minutes on, 10 minutes off). The system cycles less often when load conditions are less than or greater than a 50% load. The recommended cycle rate settings are below for each heating equipment type: Standard Efficiency Gas Forced Air = 5 CPH High Efficiency Gas Forced Air = 3 CPH Oil Forced Air = 5 CPH Electric Forced Air = 9 CPH Hot Water Fan Coil = 3 CPH Hot Water Radiant Heat = 3 CPH Geothermal Radiant Heat = 3 CPH Steam = 1 CPH Gravity = 1 CPH
324	Compressor Off Time	Off 1 - 5 minutes	5 minutes	Both	The thermostat has a built in compressor protection (minimum off timer) that prevents the compressor from restarting too early after a shutdown. The minimum-off timer is activated after the compressor turns off. If there is a call during the minimum-off timer, the thermostat shows "Wait" in the display.
326	Extended Fan Run Time in Cool	0, 30, 60, 90 seconds, 2, 3, 4, 5, 6, 7, 8, 9, 10, 11, 12, 13, 14, 15 minutes	0 seconds	Both	After the call for cooling ends, the thermostat keeps the fan on for the selected amount of time for increased efficiency. This may re-introduce humidity into the living space.
326	Extended Fan Run Time in Heat	0, 30, 60, 90 seconds, 2, 3, 4, 5, 6, 7, 8, 9, 10, 11, 12, 13, 14, 15 minutes	0 seconds	Both	After the call for heating ends, the thermostat keeps the fan on for the selected amount of time for increased efficiency.

Table 2. Installer Setup (ISU) Table. (Continued)

ISU Number	Installer Setup Name	Settings	Default	Residential, Commercial or Both	Notes
400	Scheduled Periods	2 or 4 periods per day	4 periods per day	Both	Residential: 4 Periods = Wake, Leave, Return, Sleep 2 Periods = Wake, Sleep Commercial: 4 Periods = Occupied 1, Unoccupied 1, Occupied 2, Unoccupied 2 2 Periods = Occupied 1, Unoccupied 1
401	Pre-Occupancy Purge	Off 1 hour 2 hour 3 hour	Off	Commercial	Runs the fan 1 to 3 hours before each occupied period to provide a comfortable workplace upon arrival.
402	Type of Override	Standard Initiate Occupancy	Standard	Commercial	Standard: The system maintains temperatures programmed for the occupied and unoccupied time periods. Pressing OVERRIDE will allow the user to make a temporary schedule change. Initiate Occupancy: The system maintains temperature at an energy saving level until the user touches the message center area on the thermostat. Note: The message center displays Press HERE to Start Occupancy . The system will then maintain a comfortable temperature until the occupied period ends. This option is recommended for cost savings when the workplace is used infrequently or arrival times change from day to day (example - schools). After the user touches Press HERE to Start Occupancy , the user will still be able to perform a standard OVERRIDE of the schedule.
403	Override Duration	No Limit 1 to 12 Hours	3 hours	Commercial	When the user presses the OVERRIDE button, the thermostat will maintain the new temperature for at least 1 hour. The user can adjust the Hold Until time from 1 hour to the amount set for the Override Duration (1-12 hours). Default setting is 3 hours. If set to No Limit, the user can adjust the Hold Until time up to 24 hours.

Table 2. Installer Setup (ISU) Table. (Continued)

ISU Number	Installer Setup Name	Settings	Default	Residential, Commercial or Both	Notes
405	Min. Heat Recovery Ramp Rate	Off 1° F/hr to 20° F/hr	5° F/hr	Commercial	<p>Off: The heating system will begin recovery at the time that is scheduled.</p> <p>When a Minimum Recovery Ramp Rate is set, the thermostat will begin recovery early to ensure the temperature is reached at the scheduled time.</p> <p>Set a Minimum Recovery Ramp Rate based on the rate that the heating system can recover at for a cold day in your region. Default setting is 5° F / hour.</p> <p>If an outdoor sensor is installed, set an Outdoor Temperature that is representative of a cold day in your region to be associated with the Minimum Recovery Ramp Rate. The thermostat will begin recovery at the optimal time based on a calculated ramp rate, allowing the system to recover on time and save energy during changing outdoor conditions.</p> <p>During recovery, the setpoint changes at a rate in degrees per hour depending on the outdoor temperature. If there is no outdoor sensor, the Minimum Recovery Ramp Rate is used.</p>
405	Min. Heat Recovery Outdoor Temp	Off -20° F to 100°F	0° F	Commercial	<p>Off: The heating system will begin recovery at the time that is scheduled.</p> <p>When a Minimum Recovery Ramp Rate is set, the thermostat will begin recovery early to ensure the temperature is reached at the scheduled time.</p> <p>Set a Minimum Recovery Ramp Rate based on the rate that the heating system can recover at for a cold day in your region. Default setting is 5° F / hour.</p> <p>If an outdoor sensor is installed, set an Outdoor Temperature that is representative of a cold day in your region to be associated with the Minimum Recovery Ramp Rate. The thermostat will begin recovery at the optimal time based on a calculated ramp rate, allowing the system to recover on time and save energy during changing outdoor conditions.</p> <p>During recovery, the setpoint changes at a rate in degrees per hour depending on the outdoor temperature. If there is no outdoor sensor, the Minimum Recovery Ramp Rate is used.</p>

Table 2. Installer Setup (ISU) Table. (Continued)

ISU Number	Installer Setup Name	Settings	Default	Residential, Commercial or Both	Notes
406	Max. Heat Recovery Ramp Rate	Off 1° F/hr to 20° F/hr	8° F/hr	Commercial	<p>Off: The heating system will begin recovery at the time that is scheduled.</p> <p>When a Maximum Recovery Ramp Rate is set, the thermostat will begin recovery early to ensure the temperature is reached at the scheduled time.</p> <p>Set a Maximum Recovery Ramp Rate based on the rate that the heating system can recover at for a mild day in your region. Default setting is 8° F / hour.</p> <p>Set an Outdoor Temperature that is representative of a mild day in your region to be associated with the Maximum Recovery Ramp Rate. The thermostat will begin recovery at the optimal time based on a calculated ramp rate, allowing the system to recover on time and save energy during changing outdoor conditions.</p> <p>During recovery, the setpoint changes at a rate in degrees per hour depending on the outdoor temperature.</p>
406	Max. Heat Recovery Outdoor Temp	Off -20° F to 100° F	40° F	Commercial	<p>Off: The heating system will begin recovery at the time that is scheduled.</p> <p>When a Maximum Recovery Ramp Rate is set, the thermostat will begin recovery early to ensure the temperature is reached at the scheduled time.</p> <p>Set a Maximum Recovery Ramp Rate based on the rate that the heating system can recover at for a mild day in your region. Default setting is 8° F / hour.</p> <p>Set an Outdoor Temperature that is representative of a mild day in your region to be associated with the Maximum Recovery Ramp Rate. The thermostat will begin recovery at the optimal time based on a calculated ramp rate, allowing the system to recover on time and save energy during changing outdoor conditions.</p> <p>During recovery, the setpoint changes at a rate in degrees per hour depending on the outdoor temperature.</p>

Table 2. Installer Setup (ISU) Table. (Continued)

ISU Number	Installer Setup Name	Settings	Default	Residential, Commercial or Both	Notes
407	Min. Cool Recovery Ramp Rate	Off 1° F/hr to 20° F/hr	3° F/hr	Commercial	<p>Off: The cooling system will begin recovery at the time that is scheduled.</p> <p>When a Minimum Recovery Ramp Rate is set, the thermostat will begin recovery early to ensure the temperature is reached at the scheduled time.</p> <p>Set a Minimum Recovery Ramp Rate based on the rate that the cooling system can recover at for a hot day in your region. Default setting is 3° F / hour.</p> <p>Set an Outdoor Temperature that is representative of a hot day in your region to be associated with the Minimum Recovery Ramp Rate. The thermostat will begin recovery at the optimal time based on a calculated ramp rate, allowing the system to recover on time and save energy during changing outdoor conditions.</p> <p>During recovery, the setpoint changes at a rate in degrees per hour depending on the outdoor temperature. If there is no outdoor sensor, the Minimum Recovery Ramp Rate is used.</p>
407	Min. Cool Recovery Outdoor Temp	Off -20° F to 100° F	90° F	Commercial	<p>Off: The cooling system will begin recovery at the time that is scheduled.</p> <p>When a Minimum Recovery Ramp Rate is set, the thermostat will begin recovery early to ensure the temperature is reached at the scheduled time.</p> <p>Set a Minimum Recovery Ramp Rate based on the rate that the cooling system can recover at for a hot day in your region. Default setting is 3° F / hour.</p> <p>Set an Outdoor Temperature that is representative of a hot day in your region to be associated with the Minimum Recovery Ramp Rate. The thermostat will begin recovery at the optimal time based on a calculated ramp rate, allowing the system to recover on time and save energy during changing outdoor conditions.</p> <p>During recovery, the setpoint changes at a rate in degrees per hour depending on the outdoor temperature. If there is no outdoor sensor, the Minimum Recovery Ramp Rate is used.</p>

Table 2. Installer Setup (ISU) Table. (Continued)

ISU Number	Installer Setup Name	Settings	Default	Residential, Commercial or Both	Notes
408	Max. Cool Recovery Ramp Rate	Off 1° F/hr to 20° F/hr	6° F/hr	Commercial	<p>Off: The cooling system will begin recovery at the time that is scheduled.</p> <p>When a Maximum Recovery Ramp Rate is set, the thermostat will begin recovery early to ensure the temperature is reached at the scheduled time.</p> <p>Set a Maximum Recovery Ramp Rate based on the rate that the cooling system can recover at for a mild day in your region. Default setting is 6° F / hour.</p> <p>Set an Outdoor Temperature that is representative of a mild day in your region to be associated with the Maximum Recovery Ramp Rate.</p> <p>The thermostat will begin recovery at the optimal time based on a calculated ramp rate, allowing the system to recover on time and save energy during changing outdoor conditions.</p> <p>During recovery, the setpoint changes at a rate in degrees per hour depending on the outdoor temperature.</p>
408	Max. Cool Recovery Outdoor Temp	Off -20° F to 100°F	70° F	Commercial	<p>Off: The cooling system will begin recovery at the time that is scheduled.</p> <p>When a Maximum Recovery Ramp Rate is set, the thermostat will begin recovery early to ensure the temperature is reached at the scheduled time.</p> <p>Set a Maximum Recovery Ramp Rate based on the rate that the cooling system can recover at for a mild day in your region. Default setting is 6° F / hour.</p> <p>Set an Outdoor Temperature that is representative of a mild day in your region to be associated with the Maximum Recovery Ramp Rate.</p> <p>The thermostat will begin recovery at the optimal time based on a calculated ramp rate, allowing the system to recover on time and save energy during changing outdoor conditions.</p> <p>During recovery, the setpoint changes at a rate in degrees per hour depending on the outdoor temperature.</p>
409	Adaptive Recovery	No Yes	Yes	Residential	<p>No: The system will begin heating or cooling recovery at the scheduled time.</p> <p>Yes: The thermostat will begin heating or cooling recovery early to ensure that the temperature is reached at the scheduled time. The thermostat will adjust the start time of the equipment based on how quickly the scheduled temperature was reached on previous days. See page 51 for more information on Adaptive Intelligent Recovery.</p>
410	Minimum Cool Setpoint	50° F to 99° F	50° F	Both	The user cannot set the temperature below this level.
410	Maximum Heat Setpoint	40° F to 90° F	90° F	Both	The user cannot set the temperature above this level.

Table 2. Installer Setup (ISU) Table. (Continued)

ISU Number	Installer Setup Name	Settings	Default	Residential, Commercial or Both	Notes
411	Keypad Lockout	Unlocked Partially Locked Fully Locked	Unlocked	Both	Unlocked: User has access to all thermostat settings. Partially Locked: User can modify only temperature settings. Fully Locked: User cannot modify any settings.
500	Wired Sensor on S Terminals	No Yes	No	Both	This ISU is only displayed if ISU 106 was configured to Wired/Internet. Select Yes if a wired indoor, outdoor, or discharge sensor is wired to S1.
500	Wired Remote Indoor Sensor	No Yes	No	Both	Select Yes if a wired indoor sensor is wired to S1.
500	Wired Outdoor Sensor	No Yes	No	Both	Select Yes if a wired outdoor sensor is wired to S1.
500	Wired Discharge Sensor	No Yes	No	Both	Select Yes if a wired discharge sensor is wired to S1
501	Indoor Sensor Name	[Select Indoor Sensor Name]	Indoor Sensor	Both	Select a name (location) of the Wired Remote Indoor Sensor.
502	Indoor Sensor	S1		Both	Confirms type of sensor wired to S1.
503	Indoor Sensor Type	10K 20K	10K: if ISU 101 Application is Residential 20K: if ISU 101: Application is Commercial	Both	Select 10K or 20K based on the sensor installed. Refer to resistance values below: C7189U1005 = 10K ohm C7772 = 20K ohm TR21 = 20K ohm TR21-A = 10K ohm (IMPORTANT - the TR21-A must be used in combination with a TR21 sensor or another TR21-A sensor for the thermostat to calculate the correct indoor temperature reading). See "Wiring guide – Wired Indoor Sensors" beginning on page 89 for information on the sensor type you should select based on how the sensors are wired. For example, you would select 20K when you have two TR21-A (10K) sensors wired in series.
504	Use [T-Stat Sensor] for Temp Ctrl	Use T-Stat Sensor for Temp Ctrl - Yes or No	Sensors are Averaged (T-Stat Sensor and Remote)	Both	Only displayed when a wired indoor sensor is configured. Select Yes if you want the thermostat to average with wired indoor sensor. Select No if you want to sense temperature only at the wired sensor.
505	Outdoor Sensor	S1		Both	Confirms type of sensor wired to S1.
509	Discharge Sensor	S1		Both	Confirms type of sensor wired to S1.
510	Discharge Sensor Type	10K 20K	10K	Both	Select 10K or 20K based on the sensor installed. Refer to resistance values below: 50062329-001 = 10K ohm 32005180-002 = 10K ohm C7735A1000 = 10K ohm C7770A = 20K ohm C7041 = 20K ohm
511	A-Coil Low Temp. Cutoff	Off 35° F to 65° F (in 5° F increments)	Off	Both	If an optional Discharge Sensor is used, this feature can help prevent icing on the air conditioning A-Coil. When temperature reaches the limit you set, compressor(s) will shutoff while the system fan continues to run, until the temperature rises to a safe level.

Table 2. Installer Setup (ISU) Table. (Continued)

ISU Number	Installer Setup Name	Settings	Default	Residential, Commercial or Both	Notes
700	Filter Type	None Elec. Air Cleaner Media	Media	Both	
702	Number of Air Filters	1 to 2	1	Both	
711	Air Filter 1 Reminder Note: "1" is not displayed if there is only 1 filter.	Off Run Time: 10, 20, 30, 45, 60, 90, 120, 150 days Calendar: 30, 45, 60, 75 days 3, 4, 5, 6, 9, 12, 15 months	Off	Both	
711	Air Filter 2 Reminder	Off Run Time: 10, 20, 30, 45, 60, 90, 120, 150 days Calendar: 30, 45, 60, 75 days 3, 4, 5, 6, 9, 12, 15 months	Off	Both	
712	EAC Cell Reminder	Off Calendar Months: 6, 7, 8, 9, 10, 11, 12 months	Off	Both	Electronic Air Cleaner Cell Cleaning Reminder
712	EAC Pre-Filter Reminder	Off Calendar Months: 3, 4, 5, 6 months	Off	Both	Electronic Air Cleaner Pre-Filter Cleaning Reminder
712	EAC Post Filter Reminder	Off Calendar Months: 6, 7, 8, 9, 10, 11, 12 months	Off	Both	Electronic Air Cleaner Post-Filter Replacement Reminder
800	Humidifier Type	None Steam Bypass / Fan Pwr	None	Both	
803	Humidifier Wiring	U1	Thermostat defaults to the unused universal terminal U1.	Both	U1 are dry contacts that require power. See "Wiring IAQ Equipment or a Heat/Cool Stage to the Universal Terminals" beginning on page 86.
805	Window Protection	Off On	Off	Both	Requires a wired outdoor sensor or connection to the Internet. Off: The thermostat controls the humidity level to the user's desired humidity setting. Frost or condensation may appear on windows. On: The thermostat prevents frost or condensation on windows by not allowing the humidifier to run above a certain level. To prevent frost or condensation, the thermostat may turn off the humidifier before the humidity setting is reached. See "Window Protection" beginning on page 57.

Table 2. Installer Setup (ISU) Table. (Continued)

ISU Number	Installer Setup Name	Settings	Default	Residential, Commercial or Both	Notes
806	User Humidifier in Heat Mode Use Humidifier in Cool Mode Use Humidifier in Off Mode	User Humidifier in Heat Mode - No or Yes Use Humidifier in Cool Mode - No or Yes Use Humidifier in Off Mode - No or Yes	User Humidifier in Heat Mode - Yes Default varies based on heating/cooling equipment selected	Both	Heat: Includes Heat, Emergency Heat and Auto. If the system is in Auto mode, the thermostat will allow humidification if the last call was for heat. Cool: Includes Cool and Auto. If the system is in Auto mode, the thermostat will allow humidification if the last call was for cool. A discharge air temperature sensor is required to humidify in the Cool mode. Off: The thermostat will allow humidification when the system setting is Off. See "Set up Humidification" beginning on page 57.
807	Humidifier Control	Hum when Heat is On Hum when Fan is On Tstat Controls Fan Hum Controls Fan	Defaults to Hum when Heat is On when ISU 800 Humidifier Type is Bypass or Fan Pwrd Defaults to Tstat Controls Fan when ISU 800 Humidifier Type is Steam	Both	Hum when Heat is On: The thermostat turns on the humidifier only if the heat is currently running and humidification is needed. Hum when Fan is On: The thermostat turns on the humidifier only if the fan is currently running and humidification is needed. Tstat Controls Fan: The thermostat turns on the humidifier and the fan when humidification is needed. Hum Controls Fan: The thermostat turns on the humidifier when humidification is needed and the humidifier controls the fan.
808	Run Humidifier when Cool is On	Yes No	Yes	Both	Yes: Humidifier can run when the cooling system is on. No: Humidifier can NOT run when the cooling system is on.
810	Hum Tank / Filter Reminder	Off 60 Run Time Days 90 Run Time Days 6 Calendar Months 12 Calendar Months	Off	Both	This ISU is only displayed if ISU 800 Humidifier Type is Steam. Run Time Days are not shown if ISU 800 Humidifier Type is set to None.
810	Humidifier Pad Reminder	Off 60 Run Time Days 90 Run Time Days 6 Calendar Months 12 Calendar Months	Off	Both	This ISU is only displayed if ISU 800 Humidifier Type is Bypass or Fan Pwrd. Run Time Days are not shown if ISU 800 Humidifier Type is set to None.
900	Dehumidification Equipment	Residential: None A/C with Low Fan A/C with High Fan Dehumidifier Commercial: None A/C with Low Fan A/C with High Fan Hot Gas Bypass Dehumidifier	None	Both	See "Dehumidification - Residential" beginning on page 59 or "Dehumidification - Commercial" beginning on page 63.
904	Dehum Wiring	U1	Thermostat defaults to the unused universal terminal U1.	Both	U1 are dry contacts that require power. See "Wiring IAQ Equipment or a Heat/Cool Stage to the Universal Terminals" beginning on page 86.

Table 2. Installer Setup (ISU) Table. (Continued)

ISU Number	Installer Setup Name	Settings	Default	Residential, Commercial or Both	Notes
905	Dehum Terminal - U1	Normally Closed Normally Open	Defaults to Normally Closed when ISU 900 Dehum Equipment is A/C with Low Fan Defaults to Normally Open when ISU 900 Dehum Equipment is Hot Gas Bypass	Both	Choose an option appropriate for the type of equipment installed. Normally Open: U1 will normally be open and will close when the thermostat calls for dehumidification. Normally Closed: U1 will normally be closed and will open when the thermostat calls for dehumidification.
907	Dehum Over Cooling Limit	0°, 1°, 2°, 3° F	3° F	Residential	This ISU is only displayed when ISU 900 Dehum Equipment is set to A/C with Low Fan or A/C with High Fan. The thermostat uses the cooling system to reduce humidity by lowering the temperature up to 3° F below the current cool setpoint until the desired humidity level is reached. The thermostat keeps the temperature below the cooling setpoint until the desired humidity level is reached. 0° F is only an option when ISU 900 Dehum Equipment is set to A/C with Low Fan.
908	DehumControl	Basic Minimum On Time Cooling Droop Reheat	Basic	Commercial	See "Dehumidification - Commercial" beginning on page 63.
909	Dehum Minimum On Time	5 to 15 minutes	10 minutes	Commercial	This ISU is only displayed if ISU 908 Dehum Control is set to Minimum On Time. This option ensures that the compressor runs long enough to effectively reduce humidity when the cooling equipment is cycled on. The compressor will run for the "minimum on time" you set until the desired humidity level is reached.
910	Dehum Over Cooling Limit	1° F to 5° F	2° F	Commercial	This ISU is only displayed if ISU 908 Dehum Control is set to Cooling Droop. The thermostat uses the cooling system to reduce humidity by lowering the temperature up to 5° F below the current cool setpoint until the desired humidity level is reached. The thermostat keeps the temperature below the cooling setpoint until the desired humidity level is reached.

Table 2. Installer Setup (ISU) Table. (Continued)

ISU Number	Installer Setup Name	Settings	Default	Residential, Commercial or Both	Notes
912	User Dehumidifier in Heat Mode Use Dehumidifier in Cool Mode Use Dehumidifier in Off Mode	User Dehumidifier in Heat Mode - No or Yes Use Dehumidifier in Cool Mode - No or Yes Use Dehumidifier in Off Mode - No or Yes	Use Dehumidifier in Cool Mode - Yes Default varies based on heating/cooling equipment selected	Both	This ISU is only displayed when ISU 900 Dehum Equipment is set to Dehumidifier. Heat: Includes Heat, Emergency Heat and Auto. If the system is in Auto mode, the thermostat will allow dehumidification if the last call was for heat. Cool: Includes Cool and Auto. If the system is in Auto mode, the thermostat will allow dehumidification if the last call was for cool. Off: The thermostat will allow dehumidification when the system setting is Off. See "Dehumidification - Residential" beginning on page 59 or "Dehumidification - Commercial" beginning on page 63.
913	Dehum Fan Control	Tstat Controls Fan Equip Controls Fan	Tstat Controls Fan	Both	This ISU is only displayed when ISU 900 Dehum Equipment is set to Dehumidifier. Tstat Controls Fan: The thermostat turns on the dehumidifier and the fan when dehumidification is needed. Equip Controls Fan: The thermostat turns on the dehumidifier when dehumidification is needed. The fan is controlled by the equipment.
914	Run Dehumidifier when Cool is On	Yes No	Yes	Both	This ISU is only displayed when ISU 900 Dehum Equipment is set to Dehumidifier. Yes: Dehumidifier can run when the cooling system is on. No: Dehumidifier can NOT run when the cooling system is on.
918	Dehum Away Mode	Not Allowed Allowed	Not Allowed	Both	This ISU is NOT displayed when ISU 900 Dehum Equipment is None. ISU 919 to 920 are only displayed when ISU 918 Dehum Away Mode is Allowed. See "Dehumidification Away Mode" beginning on page 62.
919	Dehum Away Mode Fan Setting	Automatic On Circulate	Automatic	Both	The On and Circulate settings may re-introduce humidity into the living space.
920	Dehum Away Mode Low Limit Temp	70° F to 80° F	76° F	Both	If the cooling system is used to control humidity while Dehumidification Away Mode is active, the thermostat allows the cooling system to lower the indoor air to the Low Limit Temperature Setting to reach the dehumidification setting at ISU 920.
920	Dehum Away mode Temp Setting	70° F to 99° F	85° F	Both	The temperature maintained while Dehumidification Away Mode is active and the desired humidity level is satisfied.
920	Dehum Away mode Dehum Setting	40% to 70% (in 5% increments)	65%	Both	The desired humidity level while Dehumidification Away Mode is active.

Table 2. Installer Setup (ISU) Table. (Continued)

ISU Number	Installer Setup Name	Settings	Default	Residential, Commercial or Both	Notes
921	Dehumidifier Filter Reminder	Off 30, 60, Calendar Days 3 to 12 Calendar Months (in 1 month increments)	Off	Both	
1000	Ventilation Type	None ERV / HRV Passive (Fan Only) Fresh Air Damper	None	Both	None: The thermostat does not control ventilation. ERV/HRV: The thermostat controls an Energy Recovery Ventilator or Heat Recovery Ventilator for ventilation. Passive (Fan Only): The thermostat turns on the fan for ventilation. Fresh Air Damper: The thermostat turns on the fan and opens a fresh air damper for ventilation.
1002	Ventilation Wiring	None U1	Thermostat defaults to the unused universal terminal U1.	Both	Number of Universal Outputs: TH8321 Thermostat: U1 terminals U1 are dry contacts that require power. See "Wiring IAQ Equipment or a Heat/Cool Stage to the Universal Terminals" beginning on page 86.
1005	Ventilation Method	ASHRAE Percent On Time	Defaults to ASHRAE when ISU 101 Application is set to Residential. Percent on Time is the only choice when ISU 101 Application is set to Commercial.	Both	See "Ventilation Control Methods (ISU 1005)" beginning on page 67.
1006	Vent Fan Control	Tstat Controls Fan Equip Controls Fan	Tstat Controls Fan	Both	Tstat Controls Fan: The thermostat turns on the ventilation equipment and the fan when ventilation is needed. Equip Controls Fan: The thermostat turns on the ventilation equipment when ventilation is needed. The fan is controlled by the equipment.
1009	Number of Bedrooms	1 to 6	2 bedrooms	Residential	This ISU is only displayed when ISU 1005 Ventilation Method is set to ASHRAE (Residential only).
1009	Size of House	1000 to 5000 sq. ft. (in 100 sq. ft. increments) (90 to 460 sq. m.)	1000 sq. feet	Residential	This ISU is only displayed when ISU 1005 Ventilation Method is set to ASHRAE (Residential only).
1010	Ventilation Rate	30 to 350 CFM (in 5 CFM increments) (850 - 9900 LPM)	150	Residential	This ISU is only displayed when ISU 1005 Ventilation Method is set to ASHRAE (Residential only).
1012	Vent Percent On Time	10% to 100% (in 10% increments)	30%	Both	The thermostat operates ventilation equipment based on a percentage entered in the installer setup (ISU 1012). For example, if Percent on Time is set to 50%, the ventilation equipment will run at random times during a 1 hour period until it reaches a 50% run time (approximately 30 minutes).

Table 2. Installer Setup (ISU) Table. (Continued)

ISU Number	Installer Setup Name	Settings	Default	Residential, Commercial or Both	Notes
1012	Vent Priority	Lockouts ASHRAE	Lockouts	Residential	<p>Lockouts are Priority: The thermostat places a priority on lockouts versus the ASHRAE 62.2 ventilation standard. The thermostat will not run ventilation during the following lockout conditions (if configured) unless you manually call for ventilation:</p> <ul style="list-style-type: none"> • Lockout Ventilation during Outdoor Conditions (ISU 1013) • Lockout Ventilation on Humidification or Dehumidification Calls (ISU 1014) • Lockout Ventilation during “Sleep” (Residential) or “Unoccupied” (Commercial) program periods. Note: This option is set by the user on the Ventilation screen in the Menu. <p>ASHRAE is Priority: ASHRAE requires additional ventilation following a long off cycle. The thermostat meets the ASHRAE 62.2 ventilation standard by running additional ventilation when outdoor conditions are favorable. If ASHRAE cannot be met when outdoor conditions are favorable, the thermostat will override the outdoor lockouts and run ventilation. When using this option, it is recommended to increase the rate (CFM) of the ventilation equipment to meet the ASHRAE 62.2 ventilation standard in a shorter run time.</p> <p>Notes:</p> <ul style="list-style-type: none"> • ISU 1014 Lockout Ventilation on Humidification or Dehumidification calls is not an option when you select ASHRAE is Priority. • The ability to lockout ventilation during the “Sleep” or Unoccupied program periods is not an option when you select ASHRAE is Priority.
1013	Low Outdoor Temp Vent Lockout	Off -20° F to 40° F (in 5° F increments)	Off	Both	<p>Requires an outdoor sensor.</p> <p>This ISU is only displayed when ISU 1000 Ventilation Type is set to ERV / HRV or Fresh Air Damper.</p> <p>See “Ventilation – Outdoor Condition Lockouts (ISU 1013)” beginning on page 67.</p>
1013	High Outdoor Temp Vent Lockout	Off 80° F to 110° F (in 5° F increments)	Off	Both	<p>Requires an outdoor sensor.</p> <p>This ISU is only displayed when ISU 1000 Ventilation Type is set to ERV / HRV or Fresh Air Damper.</p> <p>See “Ventilation – Outdoor Condition Lockouts (ISU 1013)” beginning on page 67.</p>
1013	High Out. Dew Point Vent Lockout	Off 65° F to 85° F (in 5° F increments)	Off	Both	<p>Requires Internet connection.</p> <p>This ISU is only displayed when ISU 1000 Ventilation Type is set to ERV / HRV or Fresh Air Damper.</p> <p>See “Ventilation – Outdoor Condition Lockouts (ISU 1013)” beginning on page 67.</p>

Table 2. Installer Setup (ISU) Table. (Continued)

ISU Number	Installer Setup Name	Settings	Default	Residential, Commercial or Both	Notes
1014	Vent During Hum or Dehum Calls	Yes No	Yes	Both	This feature is used to help reach the user's desired humidity level by not allowing the ventilation equipment to run during a call for humidification or dehumidification. Yes: Ventilation is allowed to run during a call for humidification or dehumidification. No: Ventilation is NOT allowed to run during a call for humidification or dehumidification.
1016	Vent On High Indoor Humidity	Off On	On	Both	This ISU is only displayed when ISU 1000 Ventilation Type is set to ERV / HRV. Off: The humidity level has no effect on ventilation. On: The thermostat removes excess humidity by turning on the ventilator when the indoor humidity rises 10% above the user's humidification setting. The thermostat must be in the heat mode to ventilate on high humidity.
1017	Ventilator Core Reminder	Off 3, 6, 9, 12 Calendar Months	Off	Both	Ventilator Core Cleaning Reminder
1017	Ventilator Filter Reminder	Off 3, 6, 9, 12 Calendar Months	Off	Both	Ventilator Filter Cleaning Reminder
1100	Number of UV Devices	0, 1, 2	0	Both	Press the up/down arrows to select the number of UV devices installed in the system. Some systems may have two UV devices, one for the A-Coil and another for Air Treatment. A replacement reminder can be setup for each one. Select 0 if no UV devices are installed.
1105	UV Bulb 1 Reminder <i>Note: "1" is not displayed if there is only 1 UV Bulb</i>	Off, 6, 12, 24 Calendar Months	Off	Both	UV Bulb 1 Replacement Reminder
1105	UV Bulb 2 Reminder	Off, 6, 12, 24 Calendar Months	Off	Both	UV Bulb 2 Replacement Reminder
1200	Custom Reminders	View / Edit Custom Reminders Add Custom Reminders	None	Both	See "Customizable Reminders" beginning on page 72.
28	Backlighting	On Demand Continuous	On Demand	Both	Select Continuous or On Demand backlighting. Select Continuous backlighting if you would like the backlight to be on all the time. Select On Demand backlighting if you would like the backlight to only turn on after a key press. After you complete your changes, the screen stays lit for 45 seconds.
1400	Clock Format	12 hour 24 hour	12	Both	
1401	Daylight Saving Time	Off On	On	Both	Set to Off in areas that do not follow Daylight Saving Time.
1402	Indoor Temperature Offset	-3° F to 3° F (in 1° F increments)	0° F	Both	0° F - No difference in displayed temperature and the actual room temperature. The thermostat displays up to 3°F (1.5°C) lower or higher than the actual measured temperature.
1402	Show humidity on home screen	Yes No	Yes	Both	This option is only available if humidifier type and dehum equipment are both set to none.

Table 2. Installer Setup (ISU) Table. (Continued)

ISU Number	Installer Setup Name	Settings	Default	Residential, Commercial or Both	Notes
1402	Indoor Humidity Offset	-12% to 12% (in 1% increments)	0%	Both	0% - No difference in displayed humidity and the actual room humidity. The thermostat displays up to 12% lower or higher than the actual measured humidity.
1404	Alert Light Indicator	On Off	On	Both	The thermostat has a built in light indicator. When an alert is active, the light will be on continuous if the thermostat is powered with 24 VAC (C wire) or it will flash if the thermostat is powered with batteries only. The light also turns on when the system setting is set to Em Heat. Select On to use the light indicator or select Off to turn off the light.
1500	Dealer Name	[Dealer Name]	None	Both	Dealer information is displayed to the user when an alert is active and the user can access this information by selecting "Dealer Information" in the Menu.
1500	Dealer Phone	[Dealer Phone]	None	Both	
1501	Dealer Email Address	[Dealer Email Address]	None	Both	
1501	Dealer Website	[Dealer Website]	None	Both	
1502	Dealer Message	[Dealer Message]	None	Both	

Connect to Wi-Fi® Network

1. Touch MENU
2. Select Wi-Fi Setup.
The thermostat will scan for available Wi-Fi networks.
3. The screen displays “Finding Networks Please Wait” after which it displays a list of all Wi-Fi networks it can find.
4. Find the name of the network you want to use by pressing the arrow buttons to scroll up/down or left/right. Press the Wi-Fi network name, then press Select.

NOTE: If the Wi-Fi network name is hidden, see “Connecting to a hidden Wi-Fi network” on page 37.

5. When prompted, press the screen to edit the password (if necessary).
6. Enter the password.
Press the ▲ or ▼ buttons to change the letter or number. Press the ► button to move to the next character, or the ◀ button to move to the previous character. Use the ▲ or ▼ buttons at the bottom to change letter case. Press Done when complete.
7. The screen will let you know when the connection is successful.

Press Done when the connection is successful. If the connection is not successful, the screen will explain why not. See “Unsuccessful connection” on page 38. Follow instructions on the screen to try again.

NOTE: Press the ▼ for more information about an unsuccessful connection.

8. If you want remote access to the thermostat, you must set up an account at mytotalconnectcomfort.com and add the thermostat to the account.

NOTE: You will need the thermostat MAC and CRC IDs to add the thermostat. They are on the screen under Menu, Wi-Fi Setup and on the Thermostat ID Card packed with the thermostat.



M35352

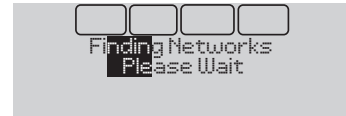

M35349



M35347



M35350

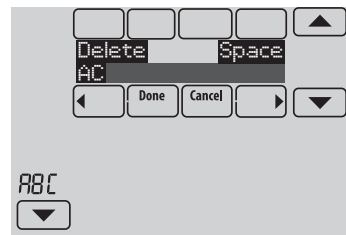

M35346

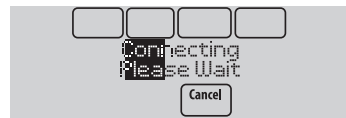

M35360



M35351



M35361A

Connect to a hidden Wi-Fi® network

1. Touch MENU, then Wi-Fi Setup.
2. Touch Other, then Select.
3. When prompted, press the screen to edit the network name.
4. Enter the network name.
Press the ▲ or ▼ buttons to change the letter or number. Press the ► button to move to the next character, or the ◀ button to move to the previous character. Use the ▲ or ▼ buttons at the bottom to change letter case. Press Done when complete.
5. Select the appropriate network security setting, then press Select.
6. Enter the Wi-Fi network password as explained above in "Connecting to Wi-Fi Network", step 6.

Unsuccessful Wi-Fi connection

If you are unsuccessful in connecting the thermostat to the Wi-Fi network, you will see a Connection Failed screen. Press ▼ button for other tips about this failed connection. Here are three specific reasons the connection might be unsuccessful.

For all Connection Failed screens, pressing Done will return to the Menu screen.

Invalid Password

The password you entered is invalid. Check that you have the right password and try again.

No IP Address

The thermostat was unable to obtain an IP address from the router. Verify the router is correctly set up to automatically assign IP addresses. This connection can take several minutes. If there is still no connection, remove the thermostat from the wallplate for 10 seconds, then snap it back into place.

No Internet Link

The thermostat connected to the Wi-Fi network but was unable to establish a connection to the internet. Check the router settings and try again. Make sure the Ethernet cable is plugged into the router and try rebooting the router if necessary.

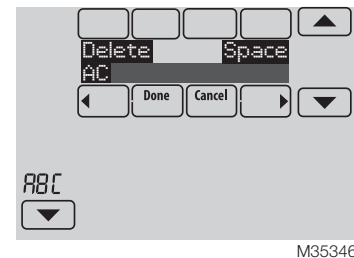

INSTALLER TESTS

Use the installer tests to check out the system:

- Equipment Test: Tests the heating, cooling, fan, and IAQ equipment. The test allows you to manually call for each system to ensure the equipment and thermostat operate properly. Any minimum off timers are ignored during the system test. You can test the following equipment:
 - Heat
 - Em Heat
 - Cool
 - Fan
 - Humidification
 - Dehumidification
 - Ventilation
 - Economizer
 - Time of Day

Accessing Installer Test

1. Press MENU on the home screen, then scroll down to Installer Options and press SELECT.
2. Enter the password (date code) when prompted. See “Finding Your Password (Date Code) to Access Installer Options” beginning on page 9 for more information.
3. Scroll down to Installer Test and press SELECT.



Fig. 23.

CAUTION
Equipment Damage Hazard.
Minimum compressor off time is bypassed during the Equipment Test
 Avoid cycling compressor quickly.

Using the Installer Test

1. Select the equipment you want to test and press the arrow buttons to turn the equipment on/off. Press Back to test the remaining equipment.

NOTE: The time out for the Equipment Test mode is 30 minutes (if there is no keypress for 30 minutes, the thermostat will automatically exit the Equipment Test).



Fig. 24.



Fig. 25.

2. Run Time and Discharge temperature are displayed for heating and cooling tests (requires Discharge Air Sensor). See Fig. 26. The Discharge temperature updates every 30 seconds during the test. The Run Time counter starts over when the next stage is turned on.

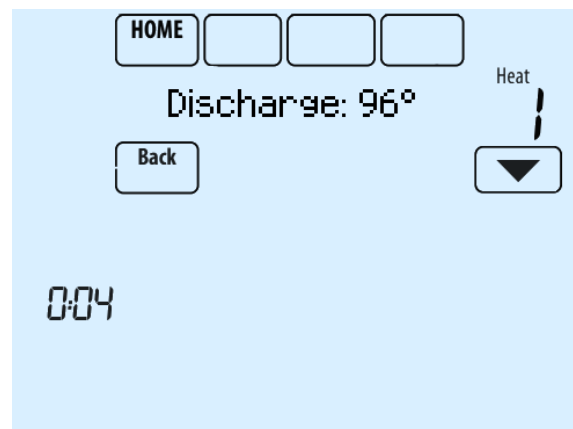

Fig. 26.

MOUNTING C7089U1006 WIRED OUTDOOR TEMPERATURE SENSOR

Do *not* mount the sensor:

- in direct sunlight.
- where hot or cold air blows on the sensor. Discharge line from an outdoor compressor unit, vent or fan causes inaccurate temperature readings.
- where snow, ice or debris can cover it.

Use the following steps to mount the sensor:

1. Remove the sensor from the mounting clip.
2. Mark the area on the location selected for mounting the sensor mounting clip.
3. Mount the clip.
4. See "Wiring C7089U1006 Outdoor Sensor" on page 88.

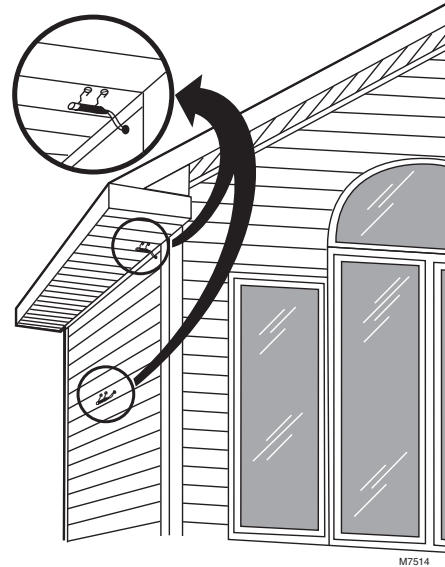

Fig. 27. Typical locations for C7089U1006 Outdoor Sensor.

OPERATION

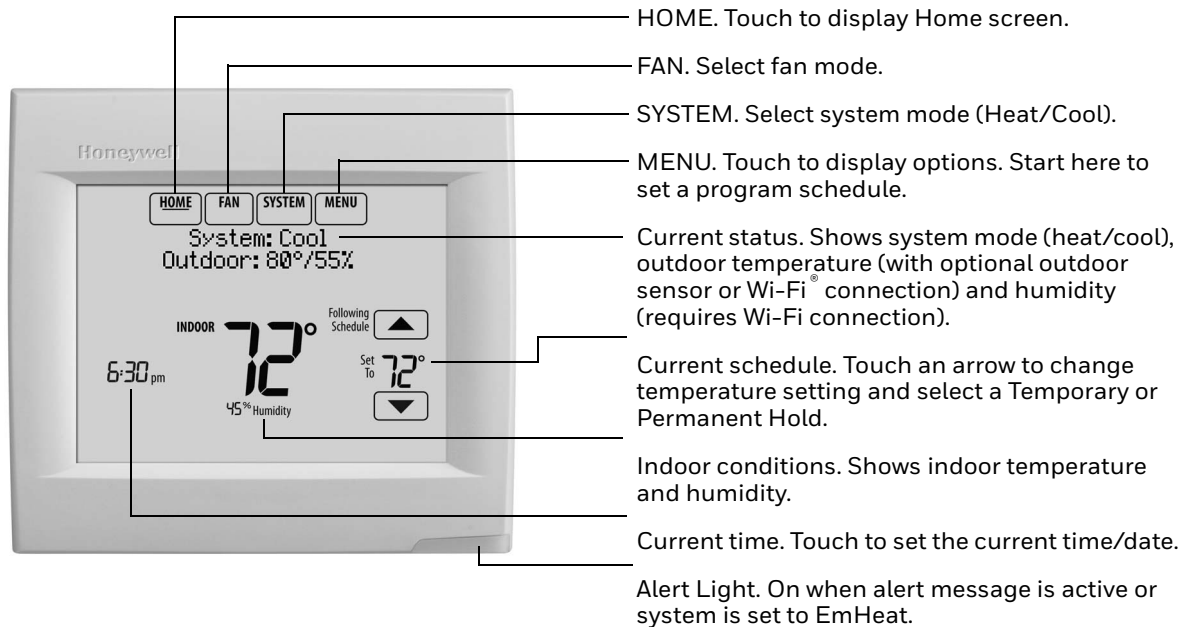

Fig. 28. Quick reference to residential display.

NOTE: The screen lights when you press any button. After you complete your changes, the screen stays lit for 45 seconds. Depending on how your thermostat was installed, the screen light may always be on.

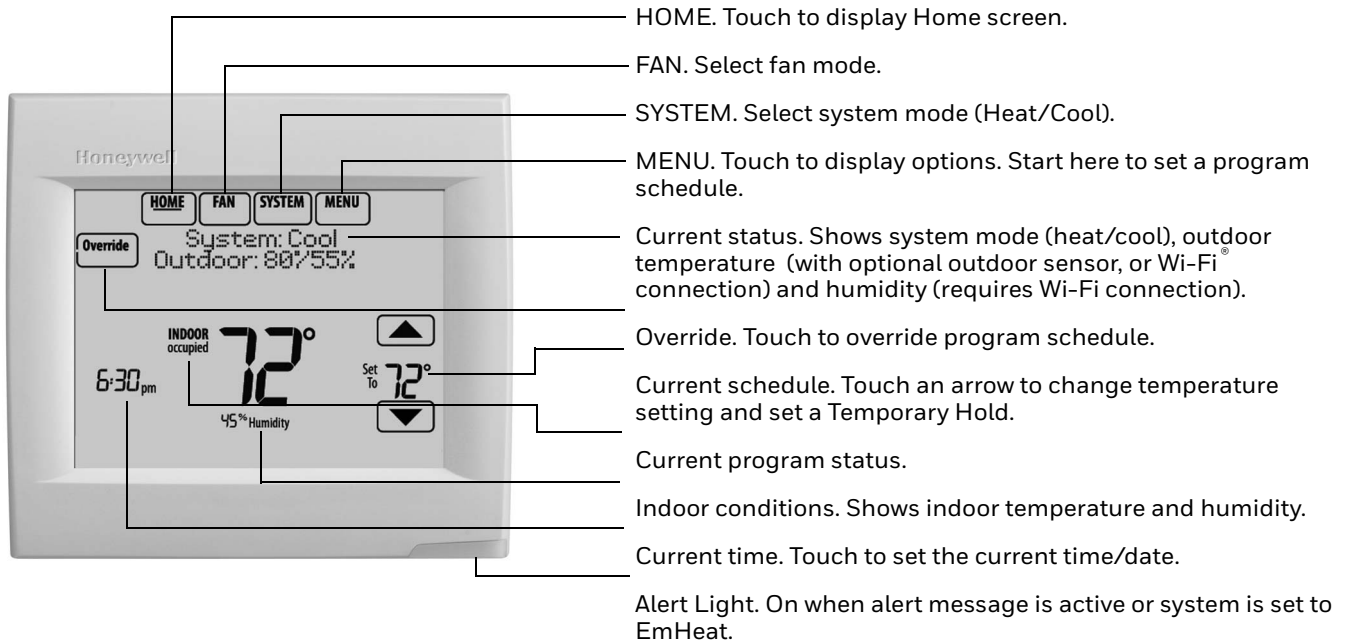

Fig. 29. Quick reference to commercial display.

NOTE: The screen lights when you press any button. After you complete your changes, the screen stays lit for 45 seconds. Depending on how your thermostat was installed, the screen light may always be on.

Setting the Time/Date

1. Touch the current time. The screen displays Select Option.



Fig. 30.

2. Touch Time or Date, then touch Select.

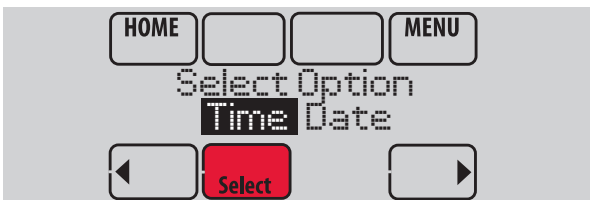

Fig. 31.

3. Touch ▲ or ▼ until the proper time/date is displayed.

4. Touch Done to save or Cancel to ignore changes.



Fig. 32.

5. Touch Home to redisplay the Home screen.

NOTE: The date is not shown on the home screen; however, it should be set to allow the thermostat to adjust time automatically for daylight saving time and for other features such as vacation hold.

Setting the Fan

1. Touch FAN to display fan settings.



Fig. 33.

2. Touch On, Auto, Circ, or Follow Schedule.

3. Touch Done to save and exit.
 - On: Fan is always on.
 - Auto: Fan runs only when heating or cooling system is on.
 - Circ: Fan runs randomly, about 35% of the time (residential only).
 - Follow Schedule: Fan controlled by program. This option may not appear, depending on how your fan was programmed.

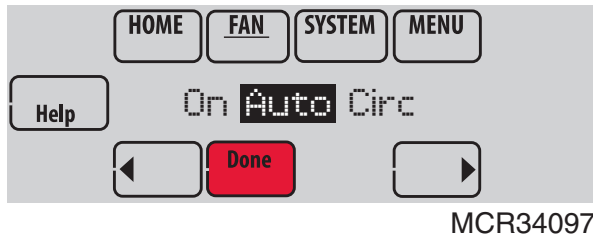

Fig. 34.

NOTE: In commercial use, touch Auto or On to temporarily override the programmed fan schedule.

Setting System Mode

1. Touch SYSTEM to display system settings.



Fig. 35.

2. Touch desired option
 - Heat: Controls only the heating system.
 - Cool: Controls only the cooling system.
 - Off: Heating/cooling systems are off.
 - Auto: Selects heating or cooling depending on the indoor temperature.
 - Em Heat (heat pumps with aux. heat): Controls auxiliary/emergency heat. Compressor is locked out.

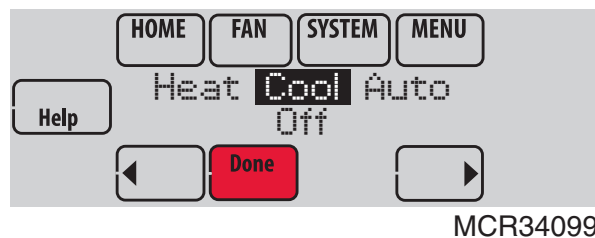

Fig. 36.

3. Touch Done to save and exit.

NOTE: The Auto and Em Heat system settings may not appear, depending on how your thermostat was installed.

Preset Energy-Saving Schedules

These default Energy Saver settings can reduce expenses.

Table 3. Residential Use Default Schedule.

Period	Start Time	Heat (Mon-Fri)	Cool (Mon-Fri)	Heat (Sat-Sun)	Cool (Sat-Sun)
Wake	6:00 am	70°	78°	70°	78°
Leave	8:00 am	62°	85°	62°	85°
Return	6:00 pm	70°	78°	70°	78°
Sleep	10:00 pm	62°	82°	62°	82°

Table 4. Commercial Use Default Schedule.

Period	Start Time	Heat	Cool	Fan
Occupied 1	8:00 am	70°	75°	On
Unoccupied 1	10:00 pm	55°	85°	Auto
Occupied 2*	12:00 am	70°	75°	On
Unoccupied 2*	12:00 am	55°	85°	Auto

* Period 2 is cancelled by default. If you activate it, the values shown above are default settings.

Adjusting Program Schedules

1. Touch MENU.



Fig. 37.

2. Select Edit Schedule to display Use Scheduling Assistant?

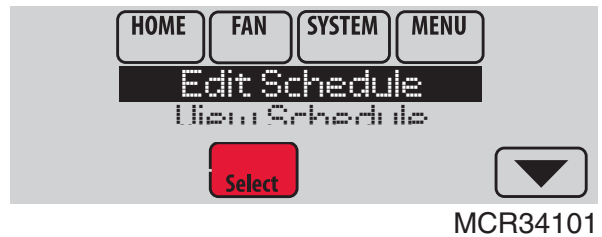
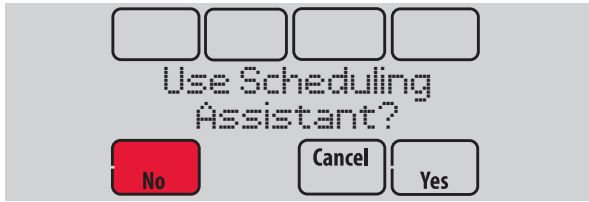

Fig. 38.

- Touch Yes to create a schedule by answering simple questions.
- Touch No to manually create a program schedule.



MCR34102

Fig. 39.

NOTE: To reduce costs, use the “Preset Energy-Saving Schedules” on page 41.

3. Select the days to schedule, touch Next.

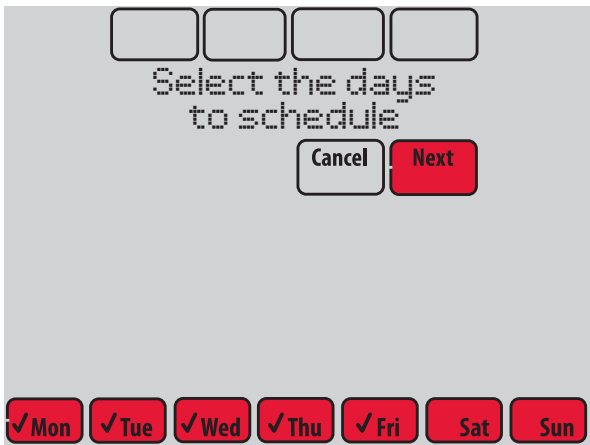

MCR34151

Fig. 40.

4. Touch ▲ or ▼ to set your Wake time for selected day(s).
5. Touch ▲ or ▼ to set Heat and Cool temperatures for the Wake period.
6. Touch other time periods (Leave, Return, Sleep) to set time and temperatures for each.
7. Touch Done to save and exit (Touch Cancel to exit without saving changes).

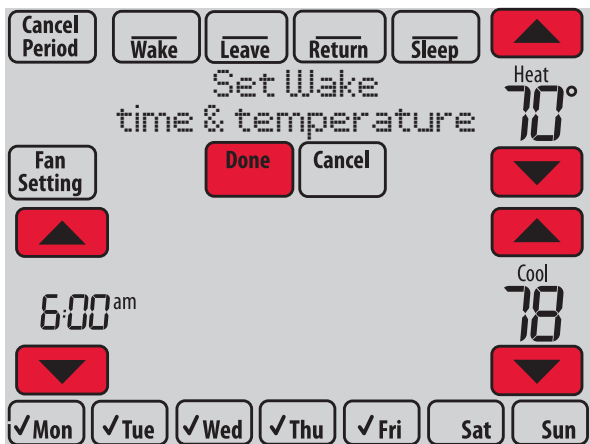

MCR34152

Fig. 41.

NOTE: Touch Cancel Period to eliminate any unwanted time period.

Touch Fan Setting to customize fan settings for any time period.

Overriding Schedules: Residential Use

1. Touch ▲ or ▼ to adjust the temperature (right side of screen) and the Hold Until time (left side). The schedule will resume when the Hold Until time expires.

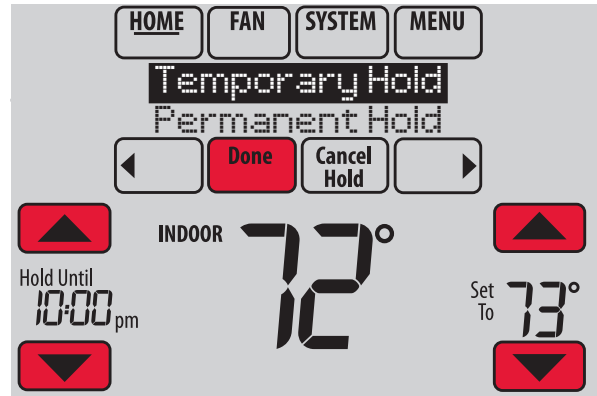

MCR34103

Fig. 42.

2. Select Permanent Hold to keep the same temperature until you change it or resume the program schedule.

Touch Cancel Hold at any time to resume the program schedule.

Overriding Schedules: Commercial Use

Touch ▲ or ▼ to adjust the temperature. It will be maintained until the hold time you set.

- To change the hold time, touch the Hold Until arrow buttons. This time can be adjusted up to the maximum time set by the installer.

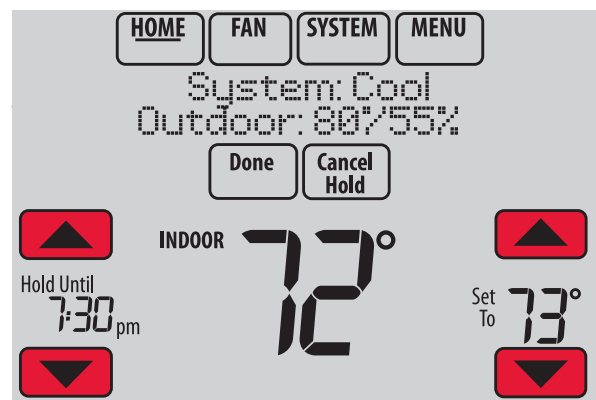

MCR34169

Fig. 43.

- Touch Override to use a pre-set occupied temperature if a person uses the room during an unoccupied period. The new temperature will be maintained for 1 hour and can be adjusted up to the maximum time set by the installer.

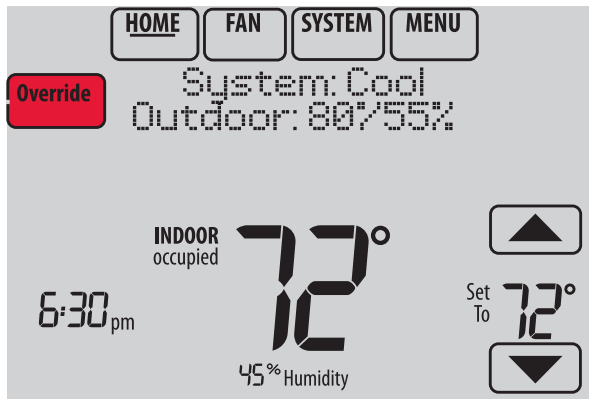

MCR34106

Fig. 44.

The programmed schedule will resume when the override timer expires. Touch Cancel Hold at any time to resume the program schedule.

Viewing Equipment Status

1. Touch MENU.



MCR34100

Fig. 45.

2. Select Equipment Status.

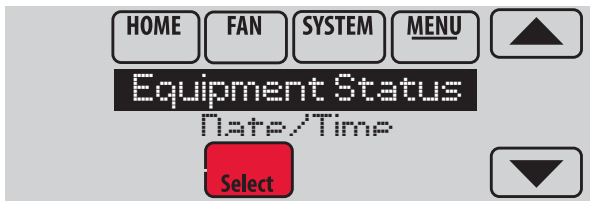

MCR34108

Fig. 46.

3. Touch ▲ or ▼ to view the status of all the equipment your thermostat is controlling. Depending on how your thermostat was installed, the Equipment Status screen can report data about the following systems:

- Heating and cooling
- Fan
- Humidification
- Dehumidification
- Ventilation
- Maintenance reminders

- Thermostat information

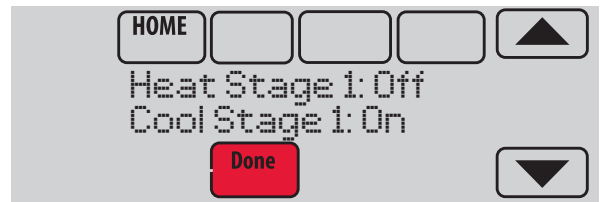

MCR34109

Fig. 47.

Setting Vacation Hold: Residential Use

This feature helps you save energy while you are away, and restores comfortable settings just before you return home.

1. Touch MENU.



MCR34100

Fig. 48.

2. Select Vacation Mode.

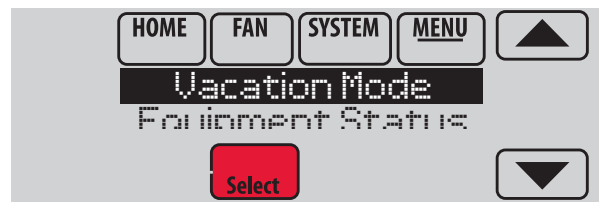

MCR34110

Fig. 49.

3. Touch ▲ or ▼ to select the date you leave, then touch Next for further scheduling details, including times of day, temperature settings, return date, and return settings.

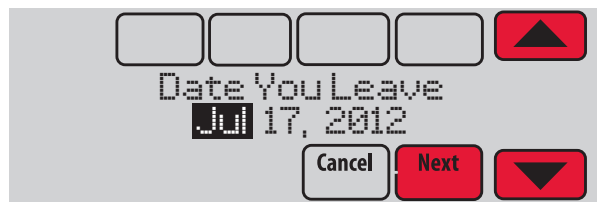

MCR34111

Fig. 50.

4. Review your selections on the last display, and touch Done to save your settings. Touch Cancel to ignore the changes.

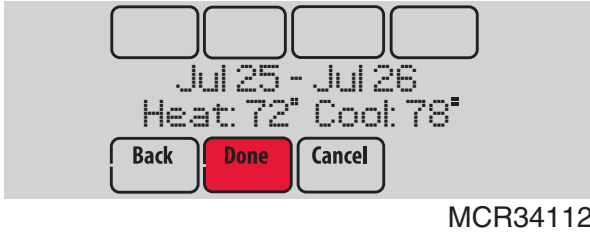

Fig. 51.

Setting Holiday/Event Schedules: Commercial Use

This feature helps you conserve energy when the workplace is unoccupied for special events and holidays.

1. Touch MENU.

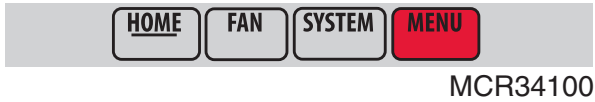

Fig. 52.

2. Select Holiday Schedule.

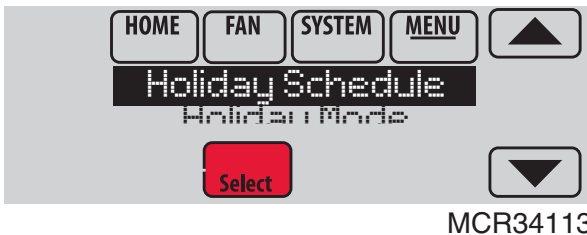

Fig. 53.

3. Select the item you want to schedule and touch Next for further scheduling details.
 - Custom Events lets you set up other days for special schedules.
 - US and Canadian Holiday options let you select from a list of holidays commonly observed in each country.



Fig. 54.

4. Make selections as prompted on each screen. For more information, see next two pages.

5. Touch Done to save your settings.

Setting Custom Events: Commercial Use

This feature lets you customize temperature settings to be maintained during a specific event. You can set up an event for a specific date or day in a month. The thermostat resumes normal scheduling after the event. The thermostat can be scheduled for up to 25 Custom Events.

1. Select Custom Events from the Holiday Schedule menu.

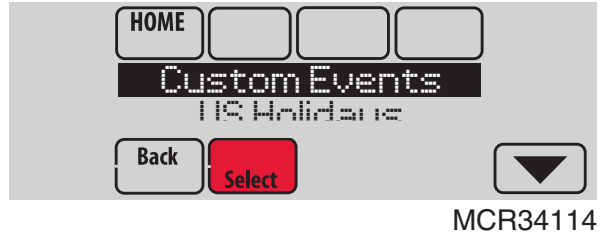

Fig. 55.

2. Select Create New Event.



Fig. 56.

3. Select Specific Date or Month/Weekday.
 - For Specific Date, you are prompted to select the event's start date, settings, end date, and frequency.
 - For Month/Weekday, you are prompted to select the month, day of the week, week of the month, settings, length of event, and frequency for the event.

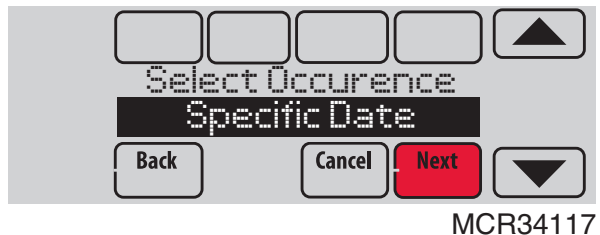

Fig. 57.

4. Review the settings and touch Done to save them. Touch Cancel to ignore the changes.

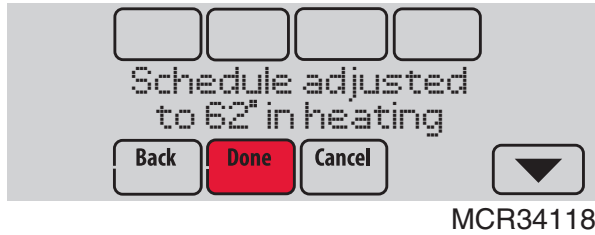

Fig. 58.

Setting Holiday Schedule: Commercial Use

This feature lets you customize temperature settings to be maintained on specified national holidays. The thermostat resumes normal scheduling between selected holidays.

1. Select US Holidays or Canadian Holidays from the Holiday Schedule menu.
2. Select Add/Edit Holidays. A list of national holidays is displayed.



Fig. 59.

3. Touch the check box next to each holiday for which you want to maintain specific settings, (Touch ▲ or ▼ to scroll through the holiday list.) then touch Next.

Set the holiday schedule for Occupied or Unoccupied temperatures, depending whether the building will be in use.

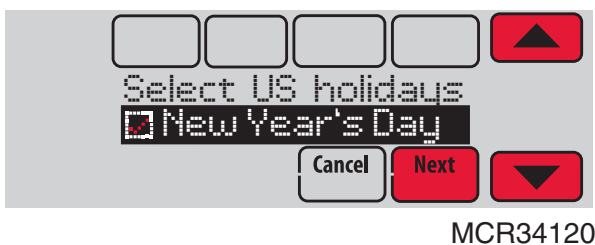

Fig. 60.

4. Touch ▲ or ▼ to select the Heat and Cool temperatures.

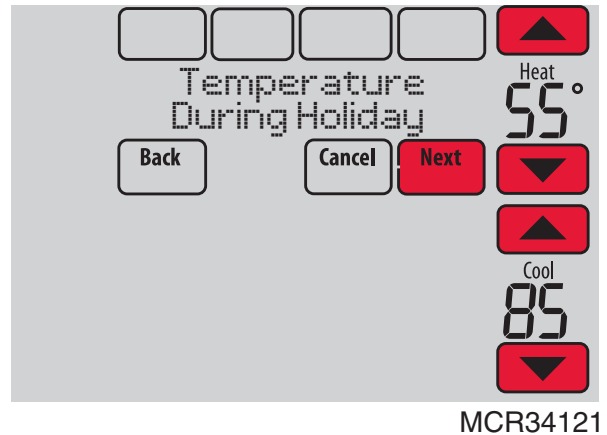

Fig. 61.

5. Review the settings and touch Done to save them. Touch Cancel to ignore changes.

Setting Holiday Override: Commercial Use

This feature lets you customize temperature settings to be maintained from now until a specified date. The thermostat resumes normal scheduling on the date you select.

1. Touch MENU.



Fig. 62.

2. Select Holiday Mode to display Temperature While Away.

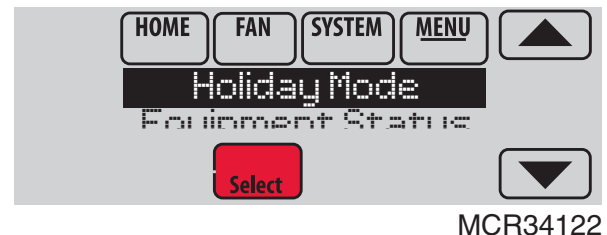

Fig. 63.

3. Touch ▲ or ▼ to select the Heat and Cool temperatures, then touch Next to select return date.

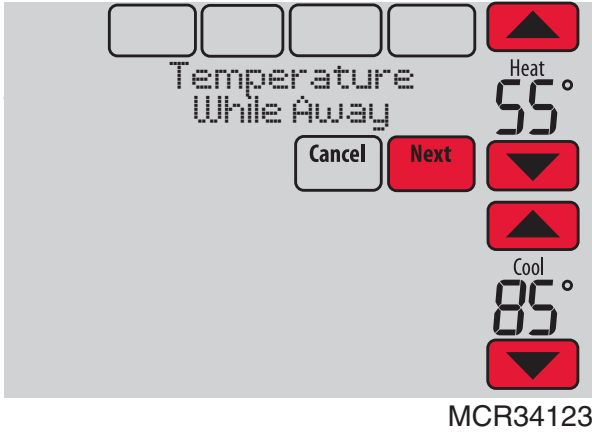

Fig. 64.

- Review the settings and touch Done to save them. Touch Cancel to ignore the changes.

NOTE: The cool temperature can only be set higher than the unoccupied program setting and the heat temperature can only be set lower than the unoccupied program setting.

Initiating Occupancy Mode: Commercial Use

This feature keeps temperature at an energy saving level until you touch Press HERE to Start Occupancy. When you arrive, touch the message to maintain a comfortable temperature while the room is occupied.

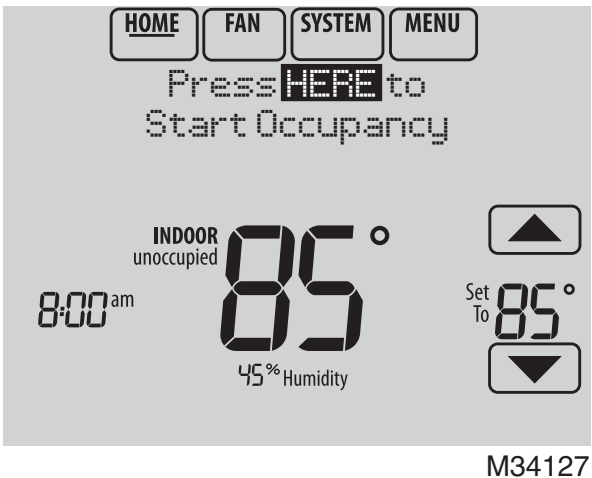

Fig. 65.

Touch the ▲ or ▼ buttons to set the temperature or the Hold Until time. The temperature is maintained until the time you set. Temperature returns to an energy-saving level after the timer expires, or the “Occupied” period ends.

NOTE: This feature is available only when programmed by the installer.

Adjusting Humidification Settings

- Touch MENU and select Humidification.

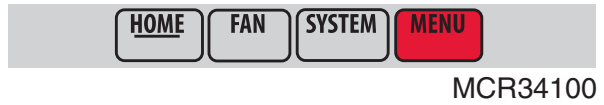

Fig. 66.

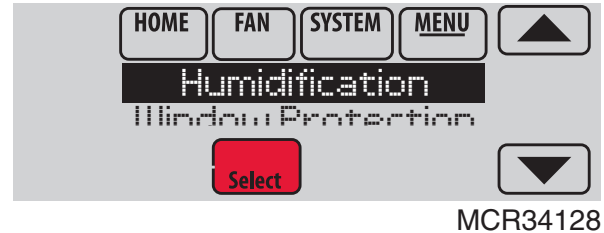

Fig. 67.

- Select Auto.

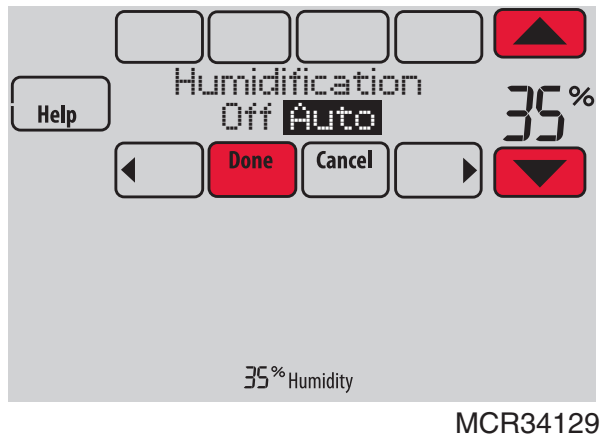

Fig. 68.

- Touch ▲ or ▼ to select humidity level.
- Touch Done to save your settings. Touch Cancel to ignore changes.
- If frost or condensation appears on the windows, press MENU, scroll down and select Window Protection.



Fig. 69.

- Window Protection is set on a scale from 1–10. A setting of 1 represents poorly insulated windows and a setting of 10 represents well insulated windows. A lower number automatically reduces the humidity to help prevent frost or condensation on your windows. Use a higher number if indoor air seems too dry. To prevent frost/condensation on your windows during

cold outdoor temperatures, poorly insulated windows require a lower Window Protection setting, which will limit how much your humidifier can run.

- After you set the Window Protection setting, check for frost/condensation on your windows in the morning. If frost/condensation is present, adjust the Window Protection setting to the next lowest number and check for frost/condensation on your windows the next morning. Continue to adjust the Window Protection setting to a lower number until frost/condensation is no longer present.

NOTE: Window Protection is available only if connected to an outdoor wired sensor or to the Internet.

NOTE: The thermostat controls humidification and dehumidification as needed to maintain the desired humidity level. Depending on how your thermostat was installed, the thermostat may maintain a 15% separation between humidification and dehumidification settings.

Adjusting Dehumidification Settings: Residential Use

This feature can control a dehumidifier or use your air conditioner to reduce humidity.

- Touch MENU and select Dehumidification.



MCR34100

Fig. 70.

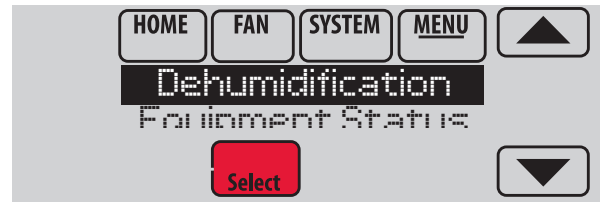

MCR34130

Fig. 71.

- Select Auto.

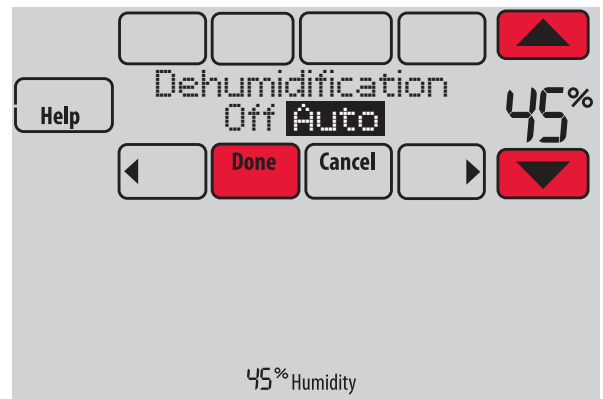

45% Humidity

MCR34131

Fig. 72.

- Touch ▲ or ▼ to select humidity level.
- Touch Done to save your settings. Touch Cancel to ignore changes.

NOTE: If your air conditioner is used to control humidity, the temperature may drop up to 3° F below your temperature setting until humidity reaches the desired level.

Adjusting Dehumidification Settings: Commercial Use

This feature can control a dehumidifier or use your air conditioner to reduce humidity.

1. Touch MENU and select Dehumidification.

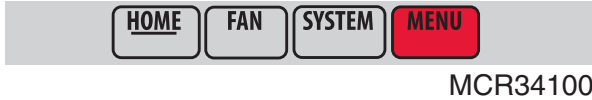

Fig. 73.

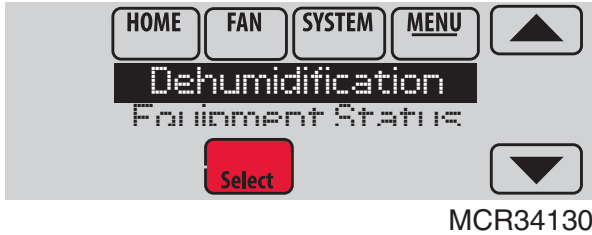

Fig. 74.

2. Select Auto.

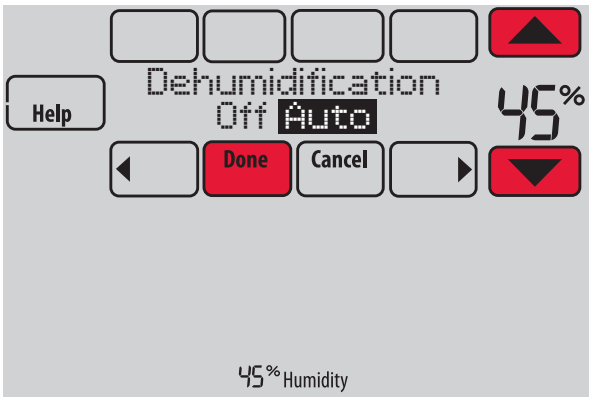

Fig. 75.

3. Touch ▲ or ▼ to select humidity level.
4. Touch Done to save your settings. Touch Cancel to ignore changes.

If your air conditioner is used to control humidity, the thermostat may use the following methods to maintain humidity:

- Cool from 1° to 5° F lower than your temperature setting.
- Run cooling for the minimum “on” time to reduce humidity.
- Run cooling and heating at the same time to reduce humidity without lowering the temperature.

Adjusting Ventilation Settings

1. Touch MENU, and select Ventilation.



Fig. 76.

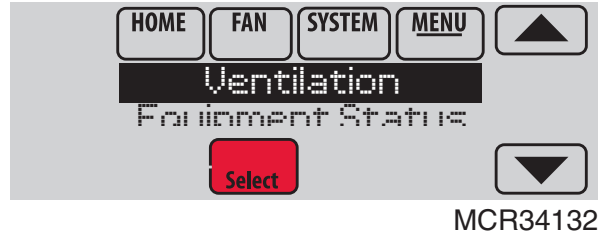

Fig. 77.

2. Select Mode, Temporary Boost, or Lockout, then select appropriate options.

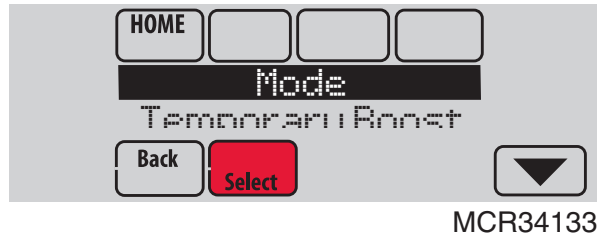

Fig. 78.

3. Touch Done to save your settings. Touch Cancel to ignore changes.



Fig. 79.

Ventilation Options

Mode:

Auto: Ventilation runs as programmed by the installer.

Off: Ventilation remains off unless turned on using the timer.

On: Ventilation is always on.

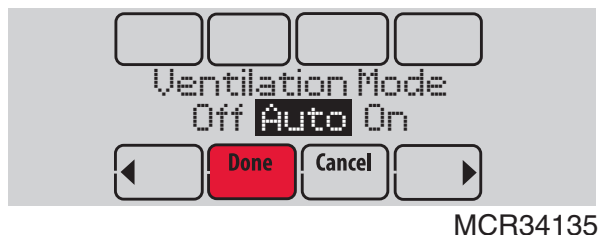

Fig. 80.

Temporary Boost: Touch ▲ or ▼ to select how long to run ventilation temporarily. To turn it off, set it to zero.

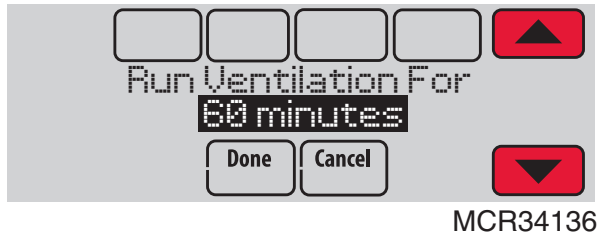

Fig. 81.

Lockout: Touch ▲ or ▼ to select Yes or No, then touch Next. Select Yes to prevent ventilation from running during the Sleep or Unoccupied (commercial) program periods or when outdoor conditions exceed values set by the installer.

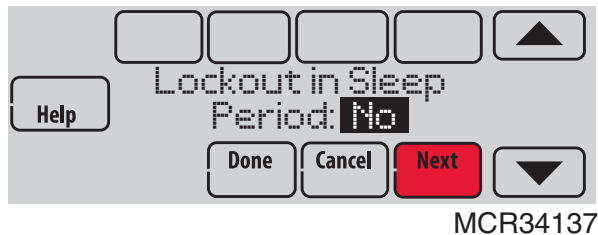

Fig. 82.

Setting Preferences

Preference menu options let you select how the thermostat displays information or responds to certain situations.

1. Touch MENU and select Preferences.



Fig. 83.

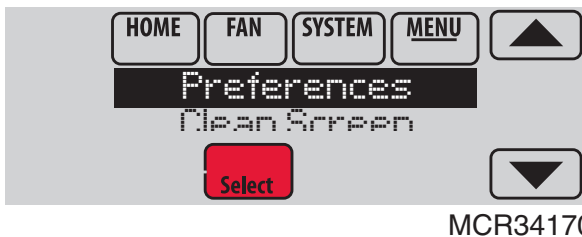

Fig. 84.

2. Select an option and follow prompts:
 - Reminders to change filters
 - Fahrenheit/Celsius display
 - 12/24-hour clock display
 - Display Options
 - Backlighting (Continuous or On Demand)
 - Inactive Backlight (Backlight level while the screen is not in use. Backlighting must be set to Continuous.)
 - Screen Contrast
 - Alert light options
 - Scheduling options
 - Adaptive recovery
 - Default schedule
 - Daylight saving time

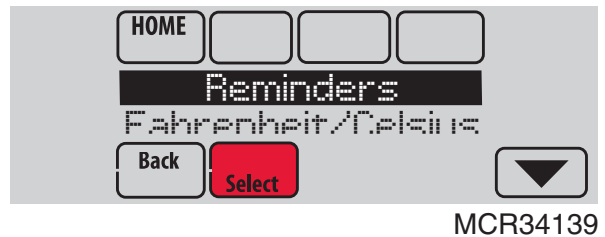

Fig. 85.

3. Touch Done to save your settings. Touch Cancel to ignore changes.

Cleaning the Thermostat Screen

When you select the Clean Screen option, the screen is locked to prevent accidental changes to the thermostat while you clean the screen.

1. Touch MENU.



Fig. 86.

2. Select Clean Screen. A prompt asks if you want to clean the screen for 30 seconds.

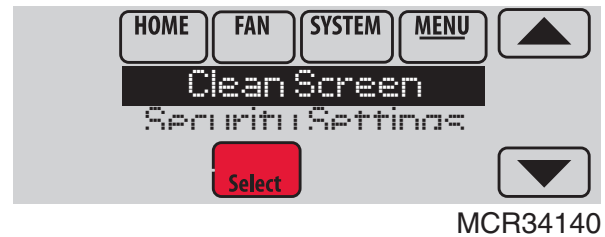

Fig. 87.

3. Touch Yes. A countdown timer displays elapsed time until the screen is reactivated.

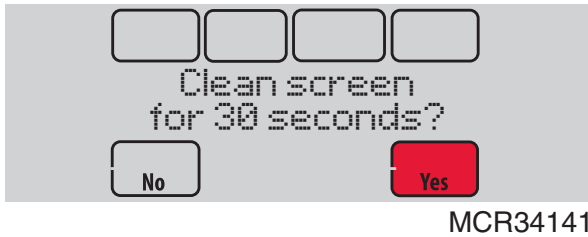

Fig. 88.

NOTE: Do NOT spray any liquid directly on the thermostat. Spray liquids onto cloth, then use the damp cloth to clean the screen. Use water or household glass cleaner. Avoid abrasive cleansers.

Adjusting Security Settings

You can adjust security options to prevent unauthorized changes to system settings.

1. Touch MENU and select Security Settings.



Fig. 89.

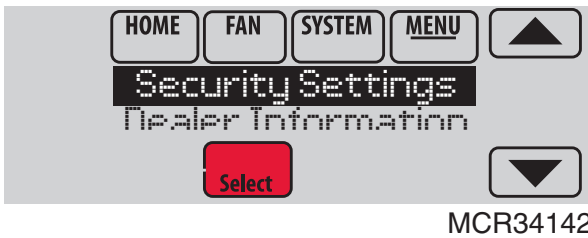

Fig. 90.

2. Select an option and follow prompts:

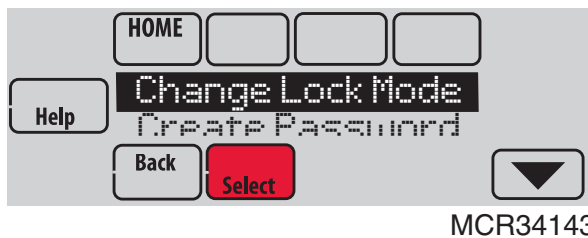

Fig. 91.

- Unlocked: Full access allowed.
- Partially locked: Only temperature can be changed.
- Fully locked: No access allowed.

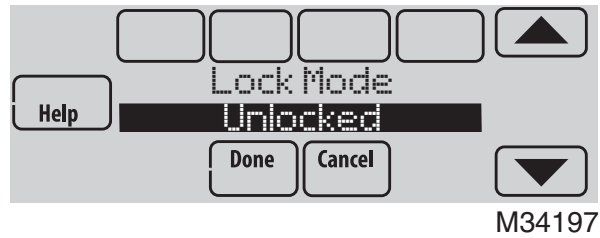
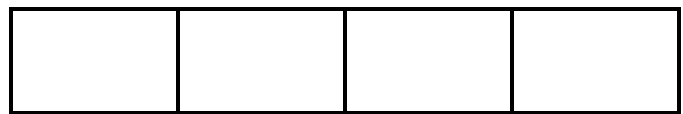

Fig. 92.

NOTE: If you choose to use a password for additional security, write it down for reference.



Viewing Dealer Information

Check dealer information if you need to contact your installer for maintenance, repairs, or upgrades.

1. Touch MENU.



Fig. 93.

2. Select Dealer Information.



Fig. 94.

3. Scroll through the displayed information.
4. Touch Done to return to the menu.

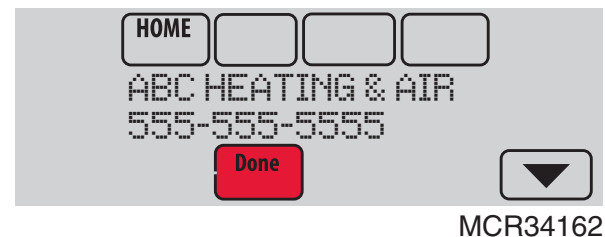

Fig. 95.

Advanced Features

ADAPTIVE INTELLIGENT RECOVERY (RESIDENTIAL USE ONLY)

Over time, the VisionPRO® thermostat "learns" how long it takes your system to reach your programmed temperature setting.

The thermostat turns on the heating/cooling system early and assures that the programmed temperature setting is reached at the programmed time regardless of weather conditions. For example, if the Wake program period is set to 6:00 am with a heat setting of 70 degrees, the heat will turn on before 6:00 am, so the temperature is 70 degrees at 6:00 am. The thermostat displays "In Recovery" when it turns the system on early.

Adaptive Intelligent Recovery® calculates the recovery ramp based on how far the room temperature is away from the temperature setting, previous equipment performance and weather history, allowing the thermostat to start recovery at the optimal time so it can reach the programmed temperature setting at the programmed time.

The VisionPRO® thermostat uses two recovery ramps when setup to control a heat pump system. One ramp for the compressor and one ramp for the auxiliary heat. Once the room temperature intersects the compressor ramp, the compressor turns on until the setpoint is reached. If the room temperature does not rise quickly enough and intersects the second ramp, the auxiliary heat turns on. It takes about one week for the thermostat to adjust to weather conditions, equipment performance and construction of the home. If the temperature setting is reached too early or too late, the ramp is adjusted for the next day's recovery. See Fig. 96.

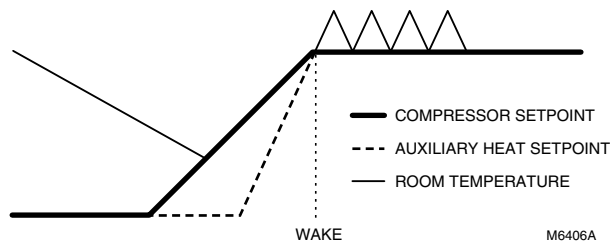

Fig. 96.

DEHUMIDIFICATION AWAY MODE

Your system can be set to control indoor climate while your home is vacant during the humid season. Before you leave, touch MENU, then select Dehum Away Mode. Temperature and humidity will be kept at levels that protect your home and possessions. When you return, touch Cancel to resume normal operation.

COMPRESSOR PROTECTION

The thermostat keeps the compressor off for a few minutes before restarting, to prevent equipment damage. During this "off" time, the message "Wait" is displayed on screen.

PRE-OCCUPANCY PURGE (COMMERCIAL USE ONLY)

This feature turns on the fan 1 to 3 hours before each "occupied" time period, to provide a comfortable workplace when you arrive.

P + I CONTROL

A conventional mechanical or electronic thermostat does not control temperature precisely at setpoint. Typically there is an offset (droop) in the control point as the system load changes. Many factors contribute to offset including the switch differential, thermal lag, overshoot, cycle rates and system load.

The VisionPRO® thermostat however, works much differently than a conventional mechanical or electronic thermostat. The proprietary algorithm in the thermostat eliminates the factors causing offset (droop). This makes temperature control more accurate than the conventional mechanical or electronic thermostat. The temperature control algorithm is called proportional plus integral (P + I) control.

The thermostat sensor or indoor sensor senses the current space temperature. The proportional error is calculated by comparing the sensed temperature to the setpoint temperature. The deviation from the setpoint is the proportional error.

The thermostat also determines integral error, which is a deviation based on the length of error time (how long the sensed room temperature has been away from the setpoint temperature). The sum of the two errors is the (P + I) error. The cycle rate used to reach and maintain the setpoint temperature is computed using the P + I control algorithm. The addition of the integral error is what differentiates the thermostat from many other mechanical and electronic thermostats. See Fig. 97.

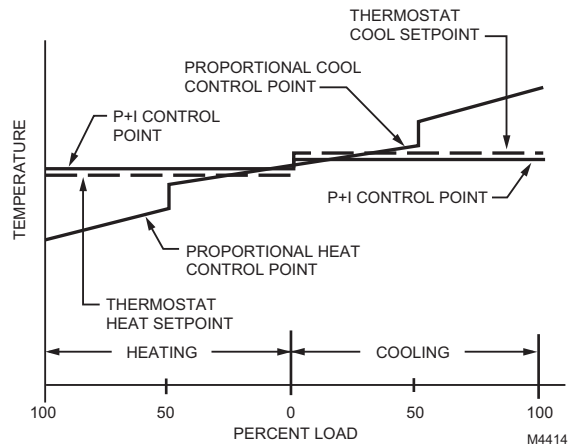

Fig. 97.

Installer Options

Installer options require a password and should only be changed by a qualified technician.



MCR34100

Fig. 98.

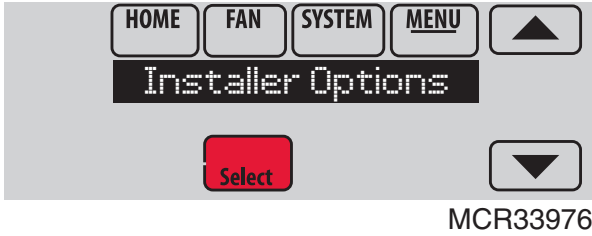

Fig. 99.

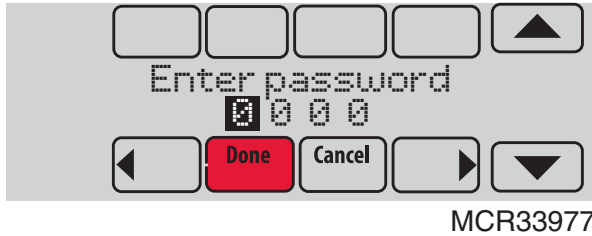
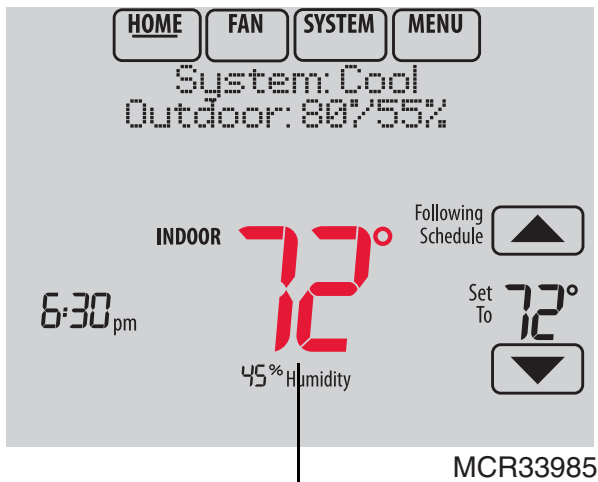

Fig. 100.

Using the Temperature Display

In some circumstances, the temperature displayed on the Home screen may not match the temperature near the thermostat.

If your system is set up to use indoor sensors, it may be reading a sensor in another location.



Temperature reading depends on location of sensor

Fig. 101.

Universal Output (U1, U1)

The U1 universal output can be setup to control IAQ equipment and a stage of heating or cooling in the Installer Setup. Setup options are listed below.

Universal Output Options

- TH8321 Thermostat Only (U1)
 - Humidification (ISU 803)
 - Dehumidification (ISU 904)
 - Ventilation (ISU 1002)
 - Cool Stage 3 (ISU 208)
 - Conventional Heat Stage 3 (ISU 210, 214)
 - Backup Heat Stage 2 for Heat Pumps (ISU 217)
 - Geothermal Radiant Heat (ISU 203)

Sensor Input (S1, S1)

The S1 input can be setup to work with a sensor. See wiring diagrams beginning on page 89. The thermostat has one Sensor Input.

Sensor Option

Indoor Air Sensor (ISU 500)

- C7189U1005 (10K)
- C7772A1004 (20K)
- C7772A1012 (20K)
- TR21 (20K)
- TR21-A (10K)

Outdoor Air Sensor (ISU 500)

- C7089U1006 (10K)

Discharge Sensors (ISU 500)

- C7735A1000 (10k)
- C7770A1006 (20K)
- C7041 (20K)

Staging Control

Differential Between All Stages

The thermostat provides Differential settings between all stages. The equipment changes stages based on how far the indoor temperature is from the setpoint. Differential settings provide a way to balance comfort and conservation.

Heat Differential

The indoor temperature must drop to the selected differential setting before the thermostat will turn on the stage of heating. For example, if stage 2 is set to 2 °F (1.0 °C), the indoor temperature must be 2 °F (1.0 °C) away from the setpoint before stage 2 turns on. When set to Comfort, the thermostat will use the stage of heating as needed to keep the indoor temperature within 1 °F (0.5 °C) degree of the setpoint. The thermostat turns on stage 2 when the capacity on stage 1 reaches 90%.

Cool Differential

The indoor temperature must rise to the selected differential setting before the thermostat turns on the stage of cooling. For example, if stage 2 is set to 2 °F (1.0 °C), the indoor temperature must be 2 °F (1.0 °C) away from the setpoint before stage 2 turns on. When set to Comfort, the thermostat uses the stage of cooling as needed to keep the indoor temperature within 1 °F (0.5 °C) degree of the setpoint. The thermostat turns on stage 2 when the capacity on stage 1 reaches 90%.

TO CHANGE DIFFERENTIAL SETTINGS

1. Select Advanced Options to view/adjust differentials between all stages.

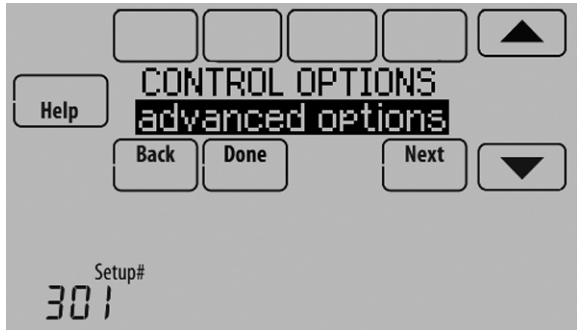

Fig. 102.

2. Default is Comfort. Adjust differentials as needed.



Fig. 103.

Backup Heat Droop

A Backup Heat Droop is available for any system with 2 heating types. For example:

- Heat Pumps with any type of Backup Heat
- Radiant Heat with any type of Backup Heat
- Hot Water Fan Coil with any type of Backup Heat

The Backup Heat Droop restricts backup heat during the following conditions:

- Normal Operation
- Manual Setpoint Changes

The options are:

- Comfort – keeps temperature within 1 degree of the setpoint.
- 2 to 15 °F – Backup heat is not used unless the indoor temperature drops to the selected Backup Heat Droop. For example, if the Backup Heat Droop is set to 2 °F (1.0 °C), the indoor temperature must be 2 °F (1.0 °C) away from the setpoint before the backup heat turns on.

NORMAL OPERATION

When the Backup Heat Droop is set to Comfort, the thermostat uses backup heat as needed to keep the indoor temperature within 1 °F (0.5 °C) of the setpoint. The Comfort setting is NOT an option on heat pumps with fossil fuel backup heat.

When the Backup Heat Droop is set to 2 °F or higher, backup heat is not used unless the indoor temperature drops to the Backup Heat Droop setting or the Backup Heat Upstage Timer expires, whichever occurs first. The upstage timer starts when the highest stage of the previous equipment type turns on.

MANUAL TEMPERATURE CHANGE

When the Backup Heat Droop is set to Comfort, the thermostat uses backup heat as needed to keep the indoor temperature within 1 °F (0.5 °C) of the setpoint. The Comfort setting is NOT an option on heat pumps with fossil fuel backup heat.

When the Backup Heat Droop is set to 2 °F or higher, if the primary heat is making progress as expected, backup heat will not be used to reach the new setpoint. Set to a higher number to use less backup heat (a greater difference between the current indoor temperature and the new setpoint is required to turn on backup heat). See notes below.

PROGRAMMED RECOVERY

If the primary heat is making progress as expected, backup heat will not be used to reach the setpoint of the next program period. Backup heat is always restricted during a programmed recovery when the Adaptive Intelligent Recovery feature is used. See note below.

NOTE: During a programmed recovery (or when the temperature setpoint is changed by the user), the thermostat waits to turn on the backup heat depending on system performance, load conditions and how many degrees the temperature setpoint is changed. Backup heat will be used ONLY when the temperature is not rising quickly enough to reach the setpoint in a reasonable time.

NOTE: If the backup heat was used in the last 2 hours because the primary heat was not able to maintain the setpoint, the thermostat may turn on the backup heat earlier when the user raises the setpoint. This does NOT apply to heat pumps with fossil fuel backup heat.

TO CHANGE BACKUP HEAT DROOP SETTINGS

1. Select Basic Options or Advanced Options to view/adjust Backup Heat Droop settings.

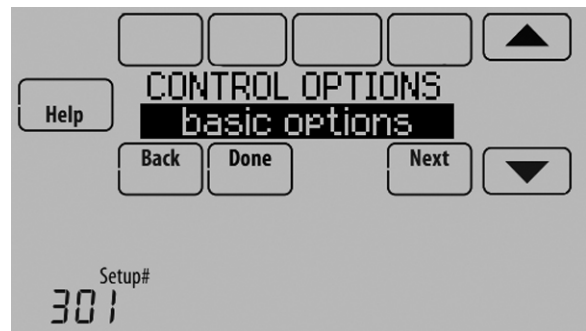

Fig. 104.

2. Default is Comfort. Adjust differentials as needed.

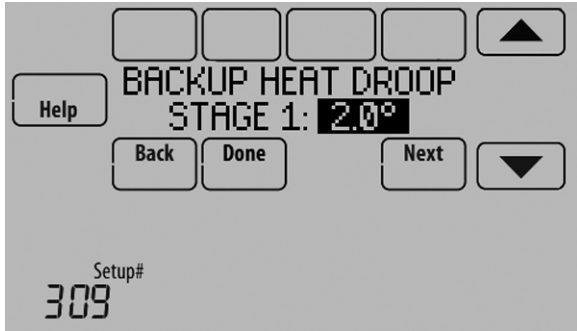

Fig. 105.

Backup Heat Upstage Timer

The Backup Heat Upstage Timer is available for any system with 2 heating types and the Backup Heat Droop is set to 2 °F (1.0 °C) or higher.

Backup heat is not used unless the indoor temperature drops to the Backup Heat Droop setting or the Backup Heat Upstage Timer expires, whichever occurs first. The upstage timer starts when the highest stage of the previous equipment type turns on.

Backup Heat Upstage Timer options are Off, 30 minutes to 16 hours. Default is Off.



Fig. 106.

Multistage Control

Multistage Control keeps the high stage of the equipment running until the desired setpoint is reached. This setting is recommended for Geothermal Heat Pumps to allow the loop to rest.

To view/adjust “Finish with High Heat Stage” or “Finish with High Cool Stage,” set ISU 301 Control Options to “Advanced Options.” See Fig. 107. Select Yes to turn on this feature. Default is No.

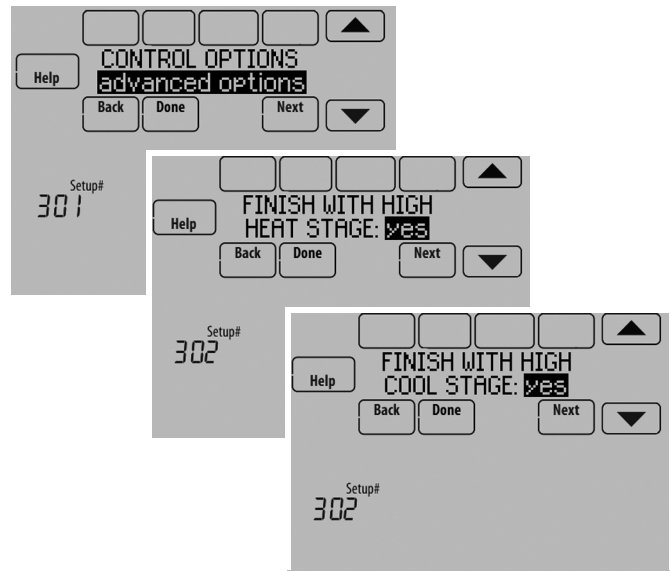

Fig. 107.

HEAT PUMP AND BACKUP HEAT OPERATION

Heat pump with outdoor temperature lockouts

Outdoor temperature lockouts are optional. See Installer Setup options (ISU 312).

Electric - Backup heat allowed to run with heat pump

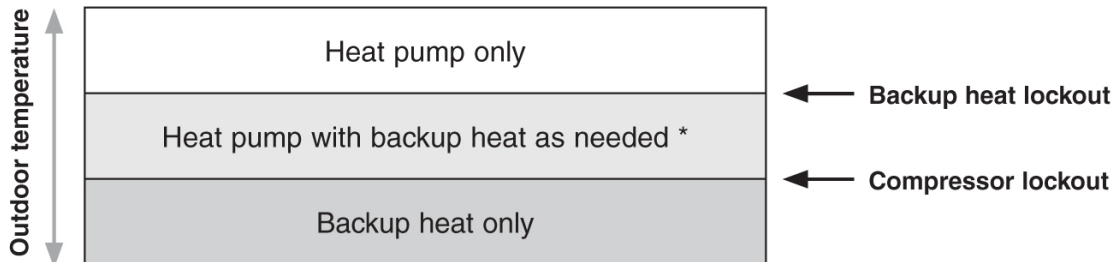

* No backup heat unless indoor temperature drops to selected Backup Heat Droop setting, or Backup Heat Upstage Timer expires. **Heat pump stays ON when backup heat turns on.**

Fossil Fuel - Backup heat NOT allowed to run with heat pump

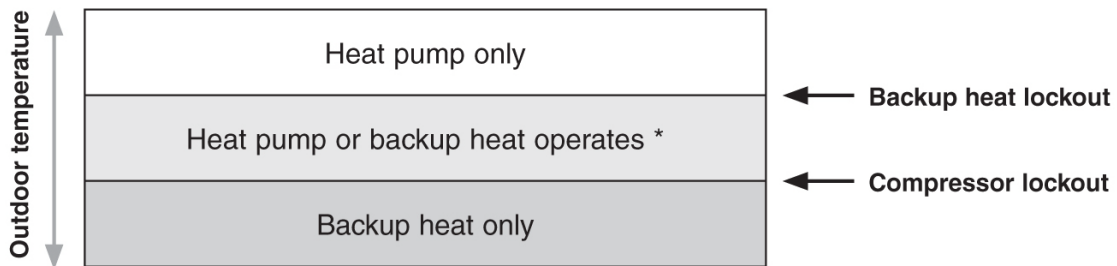

* No backup heat unless indoor temperature drops to selected Backup Heat Droop setting, or Backup Heat Upstage Timer expires. **Heat pump turns OFF when backup heat turns on.**

Alert Light - General

An alert light is located in the lower right corner of the thermostat. See Fig. 28 and 29. This light turns red when an alert is active or the system is set to the Em. Heat mode.

Alert Light - Heat Pump Systems

When the L terminal is wired to a compressor monitor and it receives 24 volts, the alert light on the thermostat will turn red to indicate a system problem. The thermostat monitors 24 volts on the L terminal in Heat, Cool and Auto modes.

Alert Light - Emergency Heat Indication

When the thermostat is setup for a Heat Pump with an Auxiliary Heat source, the alert light will turn red when the user sets the system to the Em. Heat mode. It is normal for the alert light to turn red in the Em. Heat mode to remind the user that they are currently operating their Emergency Heat and the Heat Pump is locked out.

Geothermal Radiant Heat

The thermostat can be setup to control Geothermal Radiant Heat, Geothermal Forced Air Heat and Backup Heat, all from one thermostat. The thermostat stages the equipment starting with the Geothermal Radiant Heat followed by Geothermal Forced Air Heat and then Backup

Heat as needed to maintain the desired temperature. The thermostat allows you to set differential temperature settings between each stage if you want the equipment to stage a certain way (see ISU 303 to ISU 309, page 16). For additional wiring diagrams, see "Wiring" beginning on page 84.

NOTE: To turn off Radiant Heat during the shoulder seasons, install an outdoor reset control and connect to the Radiant Heat or switch the thermostat to Emergency Heat mode.

Electric Backup Heat (Backup Heat Allowed to Run with Heat Pump)

HEAT MODE

The thermostat turns on Backup Heat only when the indoor temperature drops to the selected Backup Heat Droop setting or the Backup Heat Upstage Timer expires (whichever occurs first). Geothermal Radiant Heat and Geothermal Forced Air Heat stay on when the Backup Heat turns on.

EMERGENCY HEAT MODE

The thermostat turns on the Backup Heat to maintain the desired temperature setting. Geothermal Radiant Heat and Geothermal Forced Air Heat are not used.

Fossil Fuel Backup Heat (Backup Heat NOT Allowed to Run with Heat Pump)

HEAT MODE

The thermostat turns on Backup Heat only when the indoor temperature drops to the selected Backup Heat Droop setting or the Backup Heat Upstage Timer expires (whichever occurs first). Geothermal Forced Air Heat turns off when the Backup Heat turns on. Geothermal Radiant Heat stays on when the Backup Heat turns on.

EMERGENCY HEAT MODE

The thermostat turns on the Backup Heat to maintain the desired temperature setting. Geothermal Radiant Heat and Geothermal Forced Air Heat are not used.

Set Up Geothermal Radiant Heat

1. Select Geothermal Radiant Heat as shown in Fig. 108.

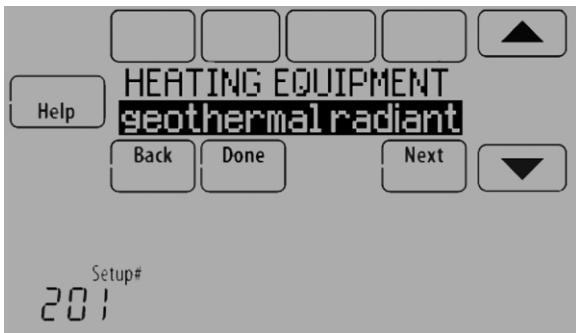

Fig. 108.

2. Select the number of Radiant Heat Stages. See Fig. 109.

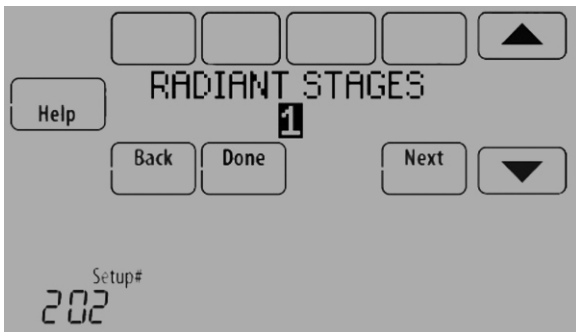

Fig. 109.

3. Select a Geothermal Forced Air Option. For example, if Geothermal Forced Air is used for both heating and cooling, select the "Heating and Cooling" option. See

Fig. 110. Other options are "None" (Geothermal Forced Air is not used) and "Cool Only" (Geothermal Forced Air is only used for cooling). See Fig. 110.



Fig. 110.

4. Select the Reversing Valve. See Fig. 111.

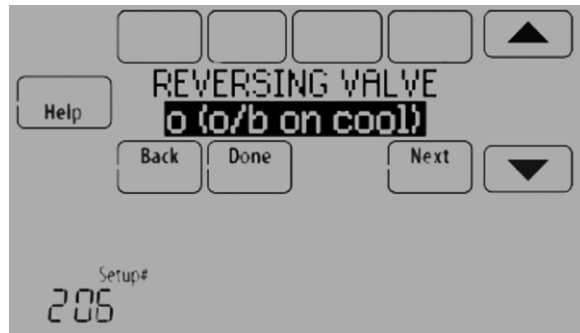

Fig. 111.

5. Select the number of Compressor and Backup Heat Stages. See Fig. 112.

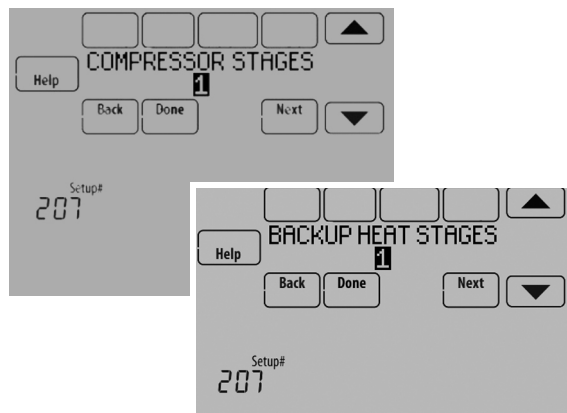

Fig. 112.

6. Select the Backup Heat Type. See Fig. 113.

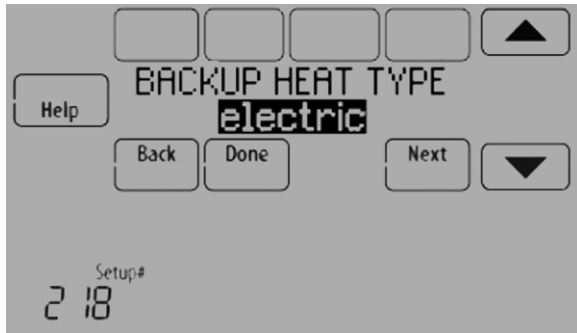

Fig. 113.

INDOOR AIR QUALITY (IAQ) CONTROL

Humidification

The thermostat reads the indoor humidity level and allows the user to set a humidification setting with or without window protection.

The thermostat can be set up to control a humidifier in any system mode in the Installer Setup (ISU 806). A discharge air sensor is required to humidify in the cool mode.

If humidification and dehumidification are setup to operate in the same system mode (Heat, Cool, Off) and you are sensing humidity from one location, the thermostat will automatically enforce a 15% deadband between the humidification and dehumidification settings. The thermostat will automatically switch between humidification and dehumidification to maintain the desired humidity level.

If humidification and dehumidification are setup to operate in the same system mode (Heat, Cool, Off) and you are sensing humidity from two different locations using an indoor sensor, the thermostat will allow humidification and dehumidification to operate at the same time, and there is no deadband between humidification and dehumidification settings.

Window Protection

Window Protection limits the amount of humidity to prevent frost or condensation on windows. Window Protection (ISU 805) requires an outdoor sensor.

The thermostat prevents frost or condensation on windows by not allowing the humidifier to run above a certain level. To prevent frost or condensation, the thermostat may turn off the humidifier before the humidity setting is reached.

To adjust the Window Protection setting, press MENU, scroll down and select Window Protection. Window Protection is set on a scale from 1-10. A setting of "1" represents poorly insulated windows and a setting of "10"

represents well insulated windows. A lower number automatically reduces the humidity to help prevent frost or condensation on your windows. Use a higher number if indoor air seems too dry. To prevent frost/condensation on your windows during cold outdoor temperatures, poorly insulated windows require a lower Window Protection setting, which will limit how much your humidifier can run.

After you set the Window Protection setting, check for frost/condensation on your windows in the morning. If frost/condensation is present, adjust the Window Protection setting to the next lowest number and check for frost/condensation on your windows the next morning. Continue to adjust the Window Protection setting to a lower number until frost/condensation is no longer present.



Fig. 114.

If Window Protection is turned Off, the thermostat controls the humidity level to the user's desired humidity setting. Frost or condensation may appear on windows.

Set up Humidification

1. Select the Humidifier Type at ISU 800. See Fig. 115.

NOTE: Based on the humidifier type you select, the thermostat defaults to the most commonly used settings for that humidifier type. For example, a Bypass or Fan Powered humidifier will default ISU 807 to "Hum when Heat is On." A Steam humidifier will default ISU 807 to "Tstat Controls Fan."



Fig. 115.

2. Select the terminals wired to the humidifier. See Fig. 116.

NOTE: U1 are Normally Open Dry Contacts that require power from the system transformer or a separate transformer. See “Wiring IAQ Equipment or a Heat/Cool Stage to the Universal Terminals” beginning on page 86.



Fig. 116.

3. Set Window Protection setting. See Fig. 117.

NOTE: Internet connection or wired outdoor sensor is required for Window Protection.



Fig. 117.

4. Select the system mode(s) to allow humidification. See Fig. 118.

NOTE: Heat includes Heat, Emergency Heat and Auto. If the system is in Auto mode, the thermostat will allow humidification if the last call was for heat.

Cool includes Cool and Auto. If the system is in Auto mode, the thermostat will allow humidification if the last call was for cool. A discharge sensor is required to humidify in the Cool mode. The thermostat prevents condensation in the duct work by not allowing the humidifier to run when the discharge temperature goes below the dew point tem-

perature. The humidifier is allowed to run again after the discharge temperature rises above the dew point temperature.

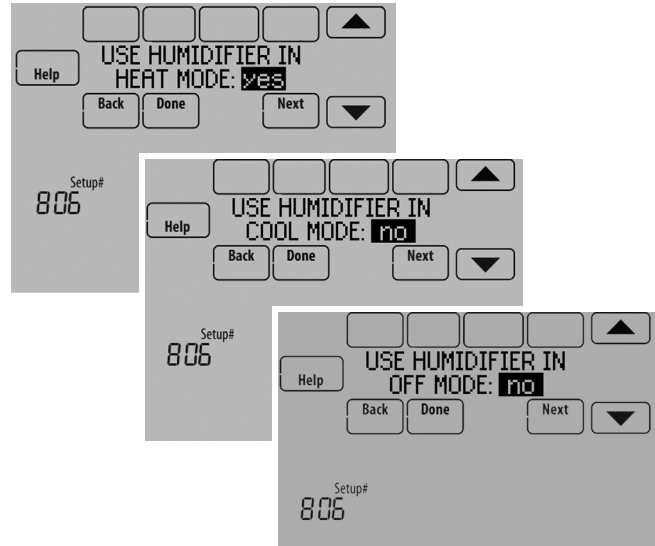

Fig. 118.

5. Select from one of the Humidification Control Options (ISU 807). See Fig. 119.
 - Hum when Heat is On
The thermostat turns on the humidifier only if the heat is currently running and humidification is needed.
 - Hum when Fan is On
The thermostat turns on the humidifier only if the fan is currently running and humidification is needed.
 - Tstat Controls Fan
The thermostat turns on the humidifier and the fan when humidification is needed.
 - Hum Controls Fan
The thermostat turns on the humidifier when humidification is needed and the humidifier controls the fan.



Fig. 119.

6. Set the desired lockout option. See Fig. 120.



Fig. 120.

NOTE: ISU 1014 gives the option to lockout ventilation during calls for humidification. This helps maintain the desired humidity level.

Control Humidification Level

1. Touch MENU and select Humidification.

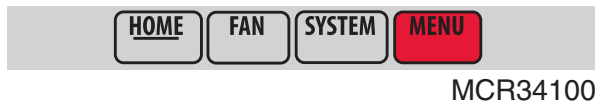

Fig. 121.

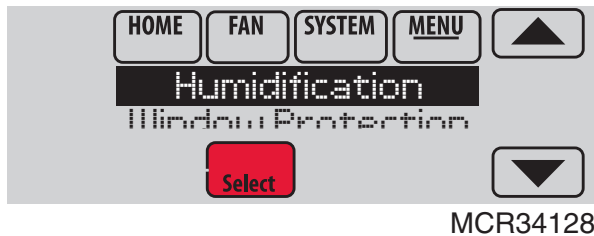

Fig. 122.

2. Select Auto.

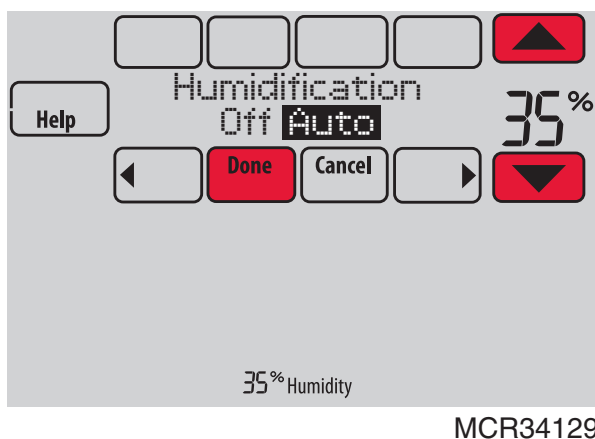

Fig. 123.

3. Touch ▲ or ▼ to select humidity level.
4. Touch Done to save your settings. Touch Cancel to ignore changes.

5. If frost or condensation appears on the windows, press MENU, scroll down and select Window Protection.



Fig. 124.

6. Window Protection is set on a scale from 1–10. A setting of 1 represents poorly insulated windows and a setting of 10 represents well insulated windows. A lower number automatically reduces the humidity to help prevent frost or condensation on your windows. Use a higher number if indoor air seems too dry. To prevent frost/condensation on your windows during cold outdoor temperatures, poorly insulated windows require a lower Window Protection setting, which will limit how much your humidifier can run.
7. After you set the Window Protection setting, check for frost/condensation on your windows in the morning. If frost/condensation is present, adjust the Window Protection setting to the next lowest number and check for frost/condensation on your windows the next morning. Continue to adjust the Window Protection setting to a lower number until frost/condensation is no longer present.

NOTE: Internet connection or wired outdoor sensor is required for Window Protection.

NOTE: If humidification and dehumidification are setup to operate in the same system mode (Heat, Cool, Off), the thermostat will automatically enforce a 15% deadband between the humidification and dehumidification settings. The thermostat will automatically switch between humidification and dehumidification to maintain the desired humidity level.

Dehumidification - Residential

The thermostat reads the indoor humidity level and allows the user to set a dehumidification setting. The thermostat controls the humidity level using the cooling system or a whole house dehumidifier.

If humidification and dehumidification are setup to operate in the same system mode (Heat, Cool, Off), the thermostat will automatically enforce a 15% deadband between the humidification and dehumidification settings. The thermostat will automatically switch between humidification and dehumidification to maintain the desired humidity level.

Dehumidification using the Cooling System

When set for A/C with Low Speed Fan or A/C with High Speed Fan, an overcooling limit can be set from 0 °F to 3 °F (ISU 907). The thermostat uses the cooling system to reduce humidity by lowering the temperature up to 3° F below the current cool setpoint until the desired humidity level is reached.

If set for A/C with Low Speed Fan, configure U1 as normally open or normally closed (ISU 905) and wire to the Low Speed Fan terminal on the equipment. For example, if the U1 terminal is normally closed, it will open when the thermostat calls for dehumidification.

NOTE: The thermostat will not lower the fan speed when the second stage of cooling is on.

Set up Dehumidification With Cooling System

Some screens shown in this section may not appear on the thermostat, depending on how you set up dehumidification.

1. Select the Dehumidification Equipment in ISU 900. See Fig. 125.

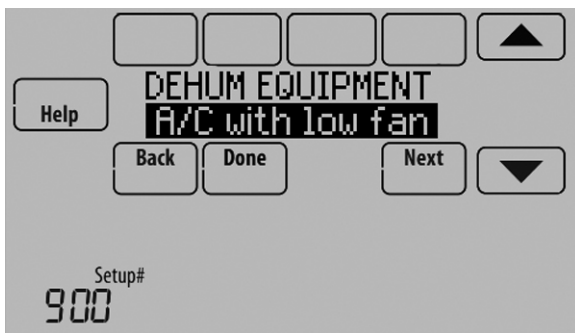

Fig. 125.



Fig. 126.

2. Select the terminals wired to the A/C with Low Speed Fan. See Fig. 127.

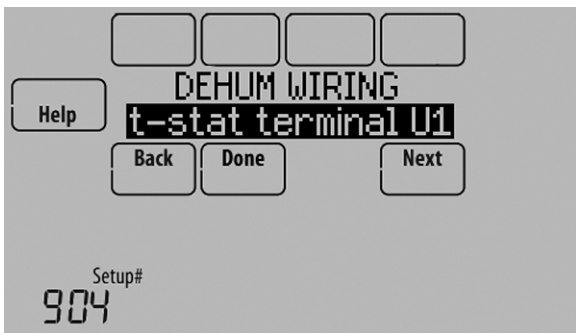

Fig. 127.

3. Select whether the U1 terminal are Normally Open or Normally Closed. See Fig. 128.
 - Normally Open – contacts are normally open and will close during a call for dehumidification
 - Normally Closed – contacts are normally closed and will open during a call for dehumidification.

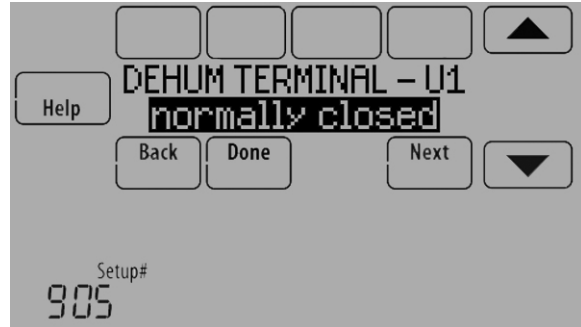

Fig. 128.

4. Set the Overcooling Limit. See Fig. 129. Options:
 - 0 °F to 3 °F (A/C with Low Speed Fan)
 - 1 °F to 3 °F (A/C with High Speed Fan)



Fig. 129.

NOTE: ISU 1014 gives the option to lockout ventilation on calls for dehumidification. This helps maintain the desired humidity level.

Dehumidification using a Whole House Dehumidifier

The Whole House Dehumidifier option requires a dedicated unit for dehumidification. The thermostat can be set to control dehumidification in all modes (Heat, Off, Cool [ISU 912]).

Set up Dehumidification With Whole House Dehumidifier

Some screens shown in this section may not appear on the thermostat, depending on how you set up dehumidification.

1. Select the Dehumidification Equipment in ISU 900. See Fig. 130.



Fig. 130.



Fig. 131.

2. Select the terminals wired to the Whole House Dehumidifier. See Fig. 132.



Fig. 132.

3. Select the system mode(s) to allow dehumidification. See Fig. 133.

NOTE: Heat includes Heat, Emergency Heat and Auto. If the system is in Auto mode, the thermostat will allow dehumidification if the last call was for heat.

Cool includes Cool and Auto. If the system is in Auto mode, the thermostat will allow dehumidification if the last call was for cool.

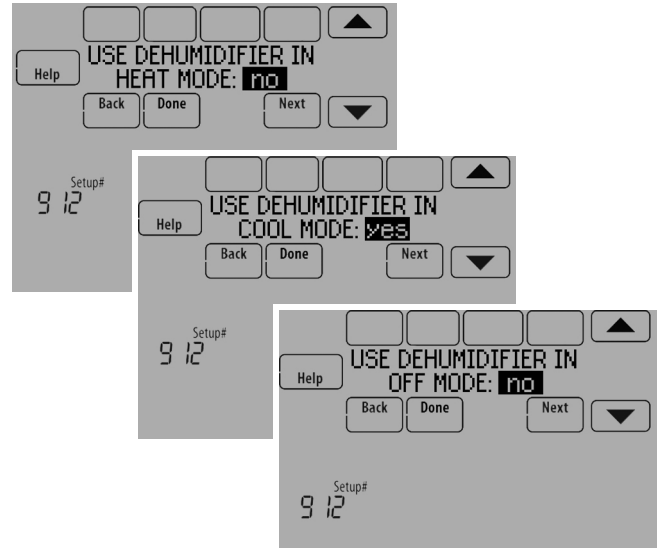

Fig. 133.

4. Set Dehumidifier Fan Control settings. See Fig. 134.
 - Tstat Controls Fan
Thermostat turns on the dehumidifier and the fan when dehumidification is needed.
 - Equip Controls Fan
Thermostat turns on the dehumidifier when dehumidification is needed. The fan is controlled by the equipment.



Fig. 134.

5. Set the desired lockout option. See Fig. 135.



Fig. 135.

NOTE: ISU 1014 gives the option to lockout ventilation during calls for dehumidification. This helps maintain the desired humidity level.

Dehumidification Away Mode

Dehumidification Away Mode protects the home when unoccupied for long periods of time during hot and humid weather by maintaining the desired humidity and temperature settings.

To start Dehumidification Away Mode, press MENU, then select Dehum Away Mode.



Fig. 136.

The thermostat automatically follows settings that are set by the dealer during installer setup.

Press Cancel to end Dehumidification Away Mode.

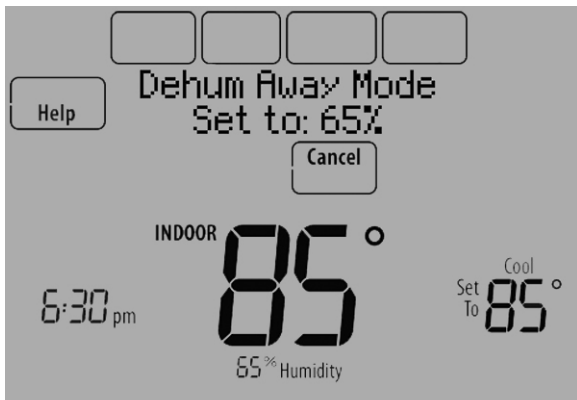

Fig. 137.

Set up Dehumidification Away Mode

1. Select Allowed at ISU 918. See Fig. 138.



Fig. 138.

2. Set Fan Control settings. See Fig. 139.
 - On: Fan is always on.
 - Automatic: Fan runs only when cooling system is on.
 - Circulate: Fan runs randomly, about 35% of the time.

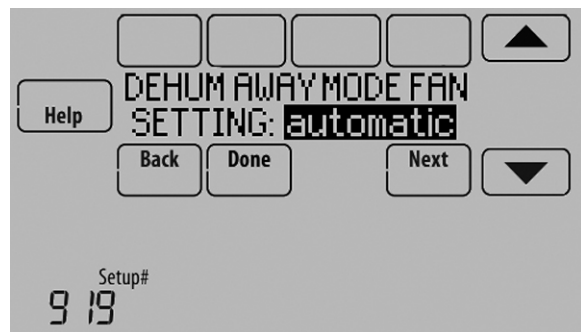

Fig. 139.

3. Set temperature and dehumidification settings. See Fig. 140.

- **Low Limit Temperature Setting**
If the cooling system is used to control humidity while Dehumidification Away Mode is active, the thermostat allows the cooling system to lower the indoor air to the Low Limit Temperature Setting to reach the Dehumidification Setting at ISU 920.
- **Temperature Setting**
The temperature maintained while Dehumidification Away Mode is active and the desired humidity level is satisfied.
- **Dehumidification Setting**
The desired humidity level while Dehumidification Away Mode is active.

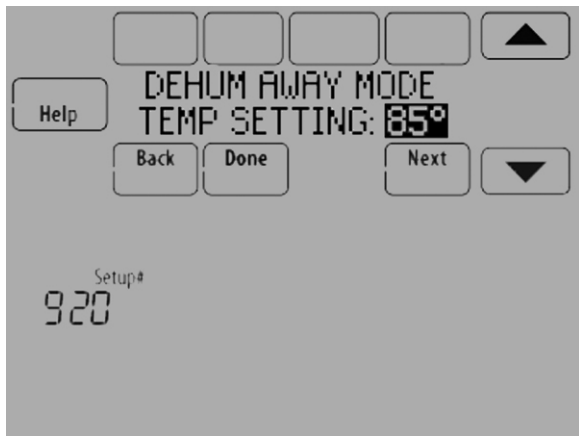

Fig. 140.

Control Dehumidification Level

1. Touch MENU and select Dehumidification.



Fig. 141.



Fig. 142.

2. Select Auto.

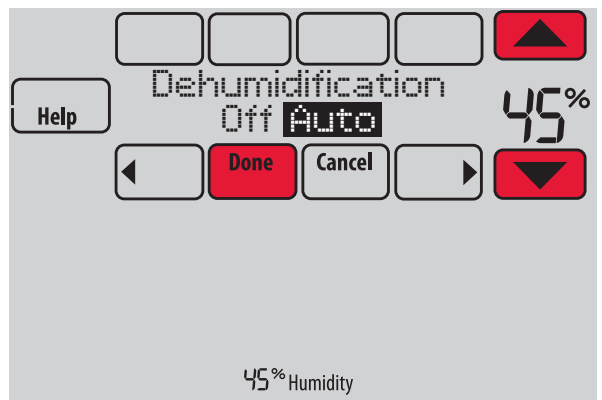

Fig. 143.

3. Touch ▲ or ▼ to select humidity level.
4. Touch Done to save your settings. Touch Cancel to ignore changes.

NOTE: If your air conditioner is used to control humidity, the temperature may drop up to 3° F below your temperature setting until humidity reaches the desired level.

NOTE: If humidification and dehumidification are setup to operate in the same system mode (Heat, Cool, Off), the thermostat will automatically enforce a 15% deadband between the humidification and dehumidification settings. The thermostat will automatically switch between humidification and dehumidification to maintain the desired humidity level.

Dehumidification - Commercial

The thermostat reads the indoor humidity level and allows the user to set a dehumidification setting. The thermostat controls the humidity level using the cooling system or a dehumidifier.

If humidification and dehumidification are setup to operate in the same system mode (Heat, Cool, Off), the thermostat will automatically enforce a 15% deadband between the

humidification and dehumidification settings. The thermostat will automatically switch between humidification and dehumidification to maintain the desired humidity level.

Dehumidification Equipment Options: (ISU 900)

- A/C with Low Fan
- A/C with High Fan
- Hot Gas Bypass
- Dehumidifier

NOTE: Hot Gas Bypass - During a call for dehumidification, the cooling capacity will be used to remove more latent heat than sensible heat. The operation of Hot Gas Bypass varies by equipment. For more details, contact the equipment manufacturer.

Dehumidification using the Cooling System

Dehumidification using A/C with Low Speed Fan, A/C with High Speed Fan or Hot Gas Bypass, has the following methods of dehumidification control (ISU 908):



Fig. 144.

Basic (ISU 908): This option uses the cooling system to reach the desired humidity level. Minimum On Time, Cooling Droop and Reheat are not used with this method. This setting is commonly used if your dehumidification equipment is Hot Gas Bypass.

Minimum On Time (ISU 908 and 909): This option ensures that the compressor runs long enough to effectively reduce humidity when the cooling equipment is cycled on. The compressor will run for the minimum “on time” you set until the desired humidity level is reached.

Cooling Droop (ISU 908 and 910): This option uses the cooling system to lower the temperature up to 5° F below the current cool setpoint until the desired humidity is reached. The Dehum Over Cooling Limit range is from 1° to 5° F.

Cooling Droop with Minimum On Time (ISU 908, 909, and 910): This method uses both options above to reduce humidity while maintaining a comfortable temperature.

Reheat (ISU 908): This option allows heating to run during dehumidification to help maintain a comfortable temperature. If only cooling stage 1 is used, during the “off” cycle, both cooling and heating run at the same time as needed to dehumidify without overcooling. This option cannot be used in the Heat mode. This option is effective only if using a system with the A-Coil located before the

heating coil (heat exchanger). This feature requires a conventional forced air heating system (gas, oil, or electric) in the application.

NOTE: Reheat can be used on heat pump applications that have a forced air backup heat source (gas, oil, or electric). The thermostat will turn on the first stage of forced air backup heat during Reheat.

NOTE: Reheat can be used on systems where the A-Coil is located after the heating coil (heat exchanger), but it is not effective at removing humidity.

Reheat with Minimum On Time (ISU 908 and 909): This method uses both Reheat and Minimum On Time options above to reach the desired humidity level.

If set for A/C with Low Speed Fan, configure U1 as normally open or normally closed (ISU 905) and wire to the Low Speed Fan terminal on the equipment. For example, if the U1 terminal is normally closed, it will open when the thermostat calls for dehumidification.

NOTE: The thermostat will not lower the fan speed when the second stage of cooling is on.

Set up Dehumidification With Cooling System

Some screens shown in this section may not appear on the thermostat, depending on how you set up dehumidification.

1. Select the Dehumidification Equipment in ISU 900. See Fig. 145.

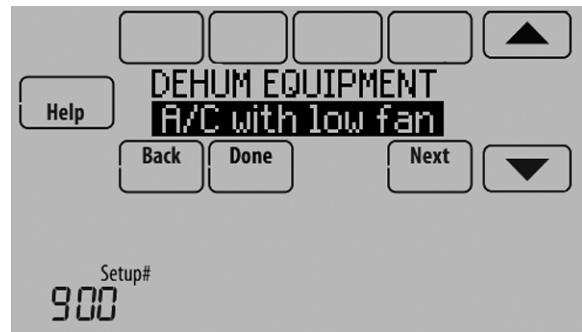

Fig. 145.

2. Select the terminals wired to the A/C with Low Speed Fan or Hot Gas Bypass. See Fig. 146.

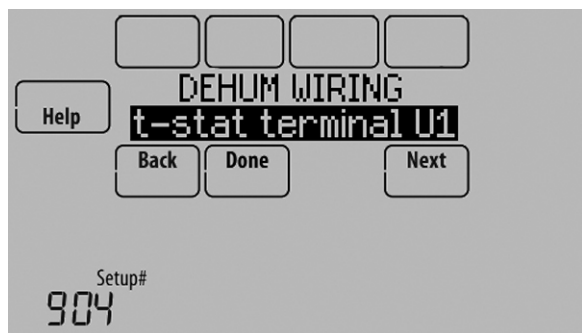

Fig. 146.

3. Select whether the U1 terminal is Normally Open or Normally Closed. See Fig. 147.
 - Normally Open – contacts are normally open and will close during a call for dehumidification
 - Normally Closed – contacts are normally closed and will open during a call for dehumidification.

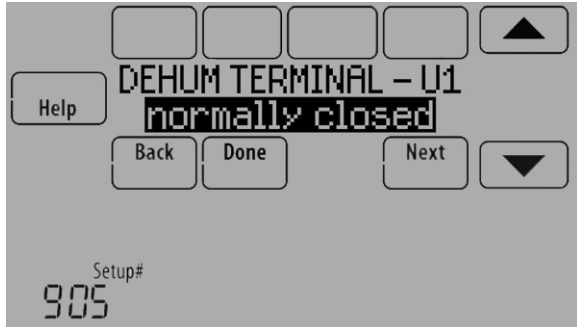

Fig. 147.

4. Set the Dehumidification Control. See Fig. 148. For more information about these options, see “Dehumidification using the Cooling System” on page 64.



Fig. 148.

NOTE: ISU 1014 gives the option to lockout ventilation on calls for dehumidification. This helps maintain the desired humidity level.

Dehumidification using a Dehumidifier

The Dehumidifier option requires a dedicated unit for dehumidification. The thermostat can be set to control dehumidification in all modes (Heat, Off, Cool [ISU 912]).

Set up Dehumidification With Dehumidifier

Some screens shown in this section may not appear on the thermostat, depending on how you set up dehumidification.

1. Select the Dehumidification Equipment in ISU 900. See Fig. 149.



Fig. 149.

2. Select the terminals wired to the Dehumidifier. See Fig. 150.

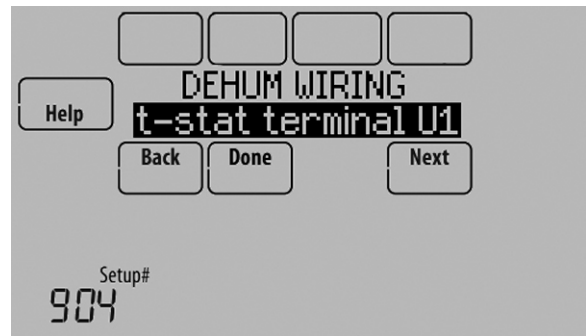

Fig. 150.

3. Select the system mode(s) to allow dehumidification. See Fig. 151.

NOTE: Heat includes Heat, Emergency Heat and Auto. If the system is in Auto mode, the thermostat will allow dehumidification if the last call was for heat.
Cool includes Cool and Auto. If the system is in Auto mode, the thermostat will allow dehumidification if the last call was for cool.

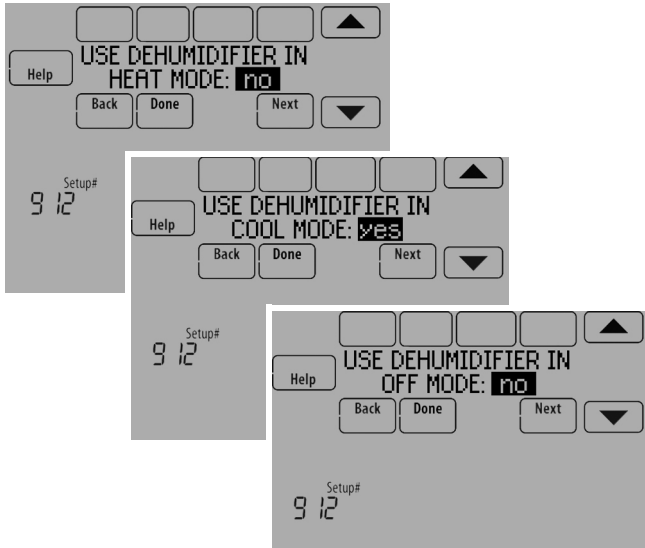

Fig. 151.

4. Set Dehumidifier Fan Control settings. See Fig. 152.
 - Tstat Controls Fan
Thermostat turns on the dehumidifier and the fan when dehumidification is needed.
 - Equip Controls Fan
Thermostat turns on the dehumidifier when dehumidification is needed. The fan is controlled by the equipment.



Fig. 152.

5. Set the desired lockout option. See Fig. 153.



Fig. 153.

NOTE: ISU 1014 gives the option to lockout ventilation on calls for dehumidification. This helps maintain the desired humidity level.

Dehumidification Away Mode

Dehumidification Away Mode for a commercial application is identical to Dehumidification Away Mode for a residential application. See "Dehumidification Away Mode" on page 62 and "Set up Dehumidification Away Mode" beginning on page 62.

Control Dehumidification Level

1. Touch MENU and select Dehumidification.



Fig. 154.

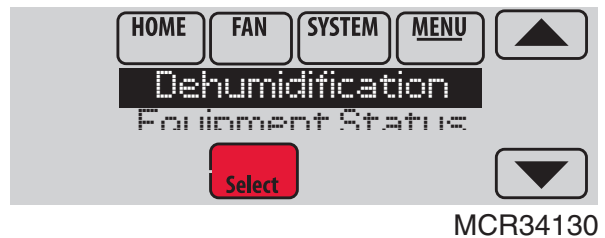
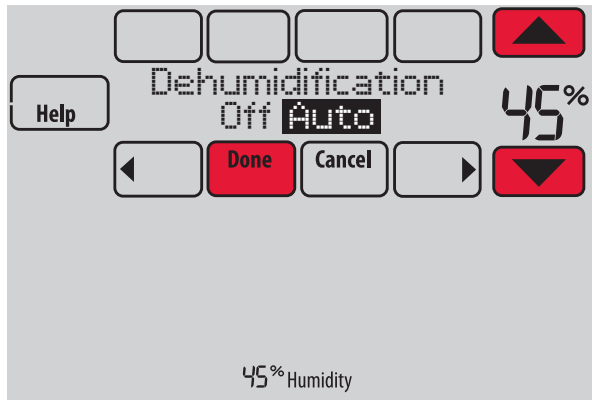

Fig. 155.

2. Select Auto.



MCR34131

Fig. 156.

3. Touch ▲ or ▼ to select humidity level.
4. Touch Done to save your settings. Touch Cancel to ignore changes.

If your air conditioner is used to control humidity, the thermostat may use the following methods to maintain humidity:

- Cool from 1° to 5° F lower than your temperature setting.
- Run cooling for the minimum “on” time to reduce humidity.
- Run cooling and heating at the same time to reduce humidity without lowering the temperature.

NOTE: If humidification and dehumidification are setup to operate in the same system mode (Heat, Cool, Off), the thermostat will automatically enforce a 15% deadband between the humidification and dehumidification settings. The thermostat will automatically switch between humidification and dehumidification to maintain the desired humidity.

Ventilation

The thermostat can be set for the following ventilation types: (ISU 1000)

- ERV/HRV
- Passive (Fan Only)
- Fresh Air Damper

Ventilation Control Methods (ISU 1005)

Ventilation can be setup to meet either ASHRAE or Percent On Time settings. To meet these settings, the thermostat will ventilate during calls for heat, cool, and fan. If the required ventilation has not been achieved for ASHRAE or Percent On Time, the thermostat will force the ventilation equipment on.

- ASHRAE
The thermostat operates ventilation equipment to meet the ASHRAE 62.2 ventilation standard based on CFM, number of bedrooms, and square footage of the house. ASHRAE 62.2 can only be met if the ventilation equipment is running. If the ventilation equipment is off for any reason (outdoor ventilation lockouts, set up to

turn Off during Sleep period, turned off by user, etc.), ASHRAE 62.2 is not met during those times. See ISU 1012 to select a Ventilation Priority.

- Percent On Time
The thermostat operates ventilation equipment based on a percentage entered in the installer setup (ISU 1012). For example if Percent On Time is set to 50%, the ventilation equipment will run at random times during a 1 hour period until it reaches a 50% run time (approximately 30 minutes). Default setting is 30%. Range is 10% to 100% in 10% increments.

Ventilation Fan Control (ISU 1006)

- Tstat Controls Fan
The thermostat turns on the ventilator and the fan when ventilation is needed.
- Equip Controls Fan
The thermostat turns on the ventilator when ventilation is needed. The fan is controlled by the equipment.

Ventilation Priority (ISU 1012)

- Lockouts are Priority
The thermostat places a priority on lockouts versus the ASHRAE 62.2 ventilation standard. The thermostat will not run ventilation during the following lockout conditions (if configured) unless you manually call for ventilation:
 - Lockout Ventilation during Outdoor Conditions (ISU 1013)
 - Lockout Ventilation on Humidification or Dehumidification Calls (ISU 1014)
 - Lockout Ventilation during “Sleep” (Residential) or “Unoccupied” (Commercial) program periods. Note: This option is set by the user on the Ventilation screen in the Menu.
- ASHRAE is Priority
ASHRAE requires additional ventilation following a long off cycle. The thermostat meets the ASHRAE 62.2 ventilation standard by running additional ventilation when outdoor conditions are favorable. If ASHRAE cannot be met when outdoor conditions are favorable, the thermostat will override the outdoor lockouts and run ventilation. When using this option, it is recommended to increase the rate (CFM) of the ventilation equipment to meet the ASHRAE 62.2 ventilation standard in a shorter run time.

NOTES: ISU 1014 Lockout Ventilation on Humidification or Dehumidification Calls is not an option when you select ASHRAE is Priority.

The ability to lockout ventilation during the “Sleep” or “Unoccupied” program periods is not an option when you select ASHRAE is Priority.

Ventilation – Outdoor Condition Lockouts (ISU 1013)

Ventilation will not operate when outdoor conditions exceed the lockout settings unless you manually call for ventilation or Ventilation Priority (ISU 1012) is set to ASHRAE is Priority and ventilation is needed to meet ASHRAE. Lockouts can prevent ventilation during extreme weather conditions to keep humid, hot, and cold air out of the home.

NOTE: This feature requires a wired sensor for outdoor temperature limits, or Internet connection for temperature and humidity lockouts.

Options are:

- Ventilation Low Temperature Lockout Setpoint (Off, -20° to 40° F)
- Ventilation High Temperature Lockout Setpoint (Off, 80° to 110° F)
- Ventilation High Dewpoint Lockout Setpoint (Off, 65° to 85° F)

Refer to the information below if you need assistance setting the High Dewpoint Lockout.

- Higher than 80: Extremely uncomfortable
- 75 to 80: Very uncomfortable
- 70 to 74: Quite uncomfortable
- 65 to 69: Somewhat uncomfortable

Ventilate on High Indoor Humidity (ISU 1016)

If set to ventilate on high indoor humidity, the ventilator turns on to remove excess humidity if the indoor humidity is 10% above the Humidification setting. The thermostat must be in the heat mode to ventilate on high indoor humidity.

Set up Ventilation

Some screens shown in this section may not appear on the thermostat, depending on how you set up ventilation.

1. Select the Ventilation Type in ISU 1000. See Fig. 157.



Fig. 157.

2. Select the terminals wired to the Ventilator (or Fresh Air Damper). See Fig. 158.

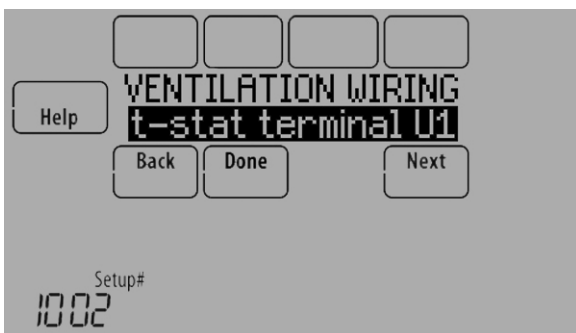

Fig. 158.

3. Select the Ventilation Control Method. See “Ventilation Control Methods (ISU 1005)” on page 67 for more information. See Fig. 159.



Fig. 159.

4. Select the Ventilation Fan Control. See “Ventilation Fan Control (ISU 1006)” on page 67 for more information. See Fig. 160.

NOTE: ISU 1006 is only displayed if the Ventilation Type is ERV / HRV. The thermostat controls the fan if the Ventilation Type is Fresh Air Damper.



Fig. 160.

5. If ASHRAE was selected for ISU 1005, select the Number of Bedrooms and Size of House. See Fig. 161.

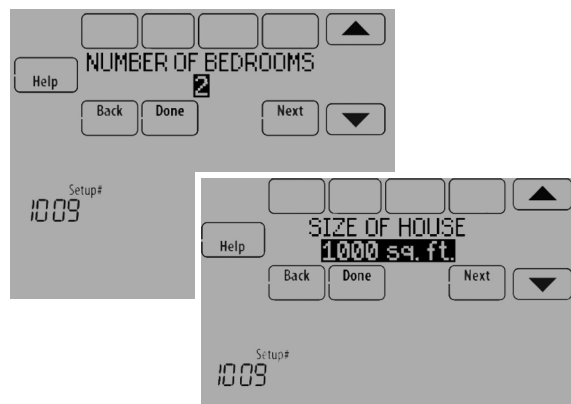

Fig. 161.

6. If ASHRAE was selected for ISU 1005, enter the Equipment Ventilation Rate (CFM). Be sure this setting corresponds with the actual ventilation speed.

This setting determines how often the ventilation equipment will operate to meet the ASHRAE 62.2 Standard. The thermostat will indicate the following based on the Equipment Ventilation Rate, Square Footage and Number of Bedrooms. See Fig. 162.

- Provides an indication if it meets or does not meet the ASHRAE 62.2 Standard.
- Provides % run time that is needed to meet the ASHRAE 62.2 Standard.

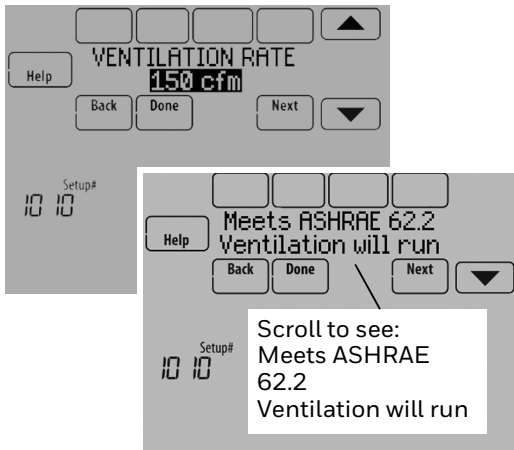

Fig. 162.

7. Select a Ventilation Priority (see Fig. 163):
 - a. Lockouts are Priority: The thermostat places a priority on lockouts versus the ASHRAE 62.2 ventilation standard. The thermostat will not run ventilation during the following lockout conditions (if configured) unless you manually call for ventilation:
 - (1) Lockout Ventilation during Outdoor Conditions (ISU 1013)
 - (2) Lockout Ventilation on Humidification or Dehumidification Calls (ISU 1014)
 - (3) Lockout Ventilation during “Sleep” (Residential) or “Unoccupied” (Commercial) program periods. Note: This option is set by the user on the Ventilation screen in the Menu.
 - b. ASHRAE is Priority: ASHRAE requires additional ventilation following a long off cycle. The thermostat meets the ASHRAE 62.2 ventilation standard by running additional ventilation when outdoor conditions are favorable. If ASHRAE cannot be met when outdoor conditions are favorable, the

thermostat will override the outdoor lockouts and run ventilation. When using this option, it is recommended to increase the rate (CFM) of the ventilation equipment to meet the ASHRAE 62.2 ventilation standard in a shorter run time.

NOTE: ISU 1014 Lockout Ventilation on Humidification or Dehumidification Calls is not an option when you select ASHRAE is Priority.

The ability to lockout ventilation during the “Sleep” or “Unoccupied” program periods is not an option when you select ASHRAE is Priority.

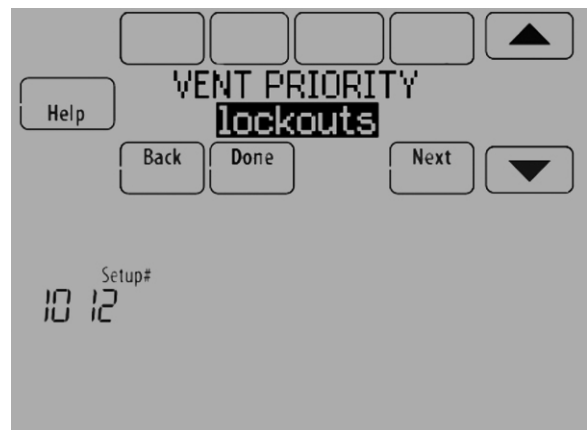

Fig. 163.

- If Percent On Time was selected for ISU 1005, select the Ventilation Percent on Time. See Fig. 164.

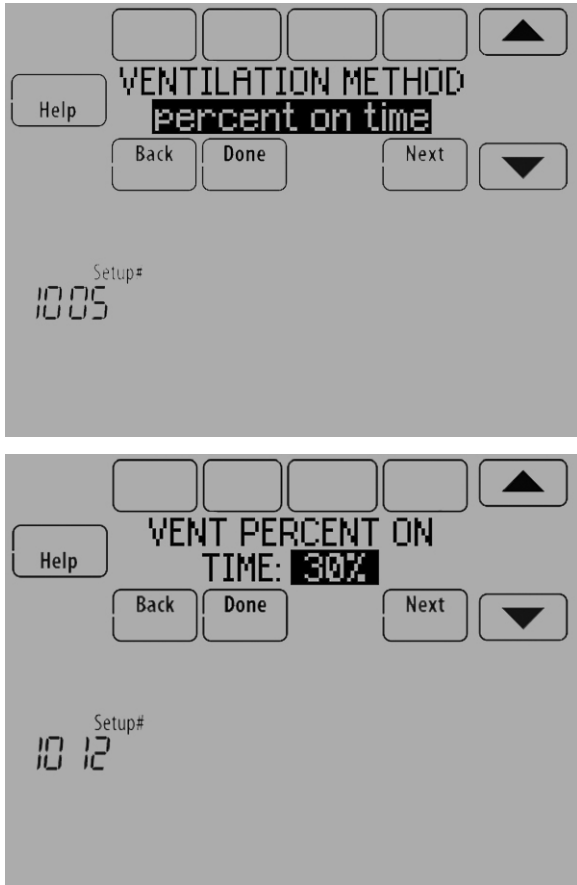

Fig. 164.

- Select the Outdoor Condition Lockouts. See Fig. 165. See "Ventilation – Outdoor Condition Lockouts (ISU 1013)" on page 67 for more information.

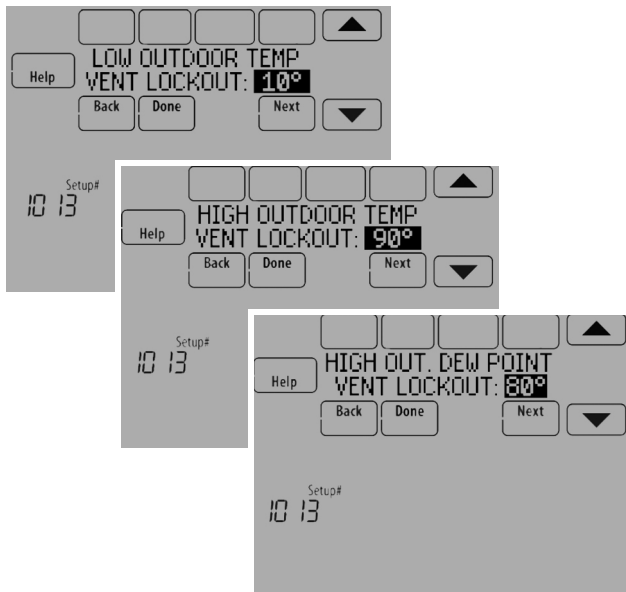

Fig. 165.

When ISU 1012 Ventilation Priority is set to Lockouts are Priority, or ISU 1005 Ventilation Control Methods is set to Percent On Time, the thermostat will indicate whether this meets or may not meet the ASHRAE 62.2 Standard or the Percent On Time setting. See Fig. 166.

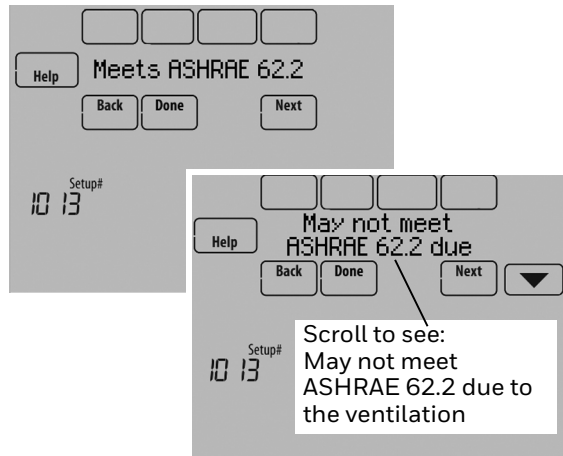

Fig. 166.

When ISU 1012 Ventilation Priority is set to ASHRAE is Priority, the screen below will indicate the maximum length of time that ventilation can be locked out over a 21 hour time period. For example, Ventilation Lockout Will Not Exceed 12.5 hours. The length of time that ventilation is locked out is limited to ensure that the ASHRAE 62.2 Ventilation Standard is met. See Fig. 167.

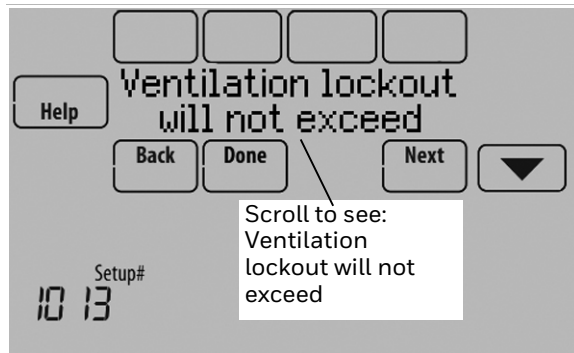

Fig. 167.

- Select whether to lockout ventilation on humidification or dehumidification calls. This feature is used to help reach the user's desired humidity level by not allowing the ventilation equipment to run during a call for humidification or dehumidification. The ther-

mostat will indicate whether this meets or may not meet the ASHRAE 62.2 Standard or the Percent On Time setting. See Fig. 168.

NOTE: ISU 1014 Lockout Ventilation on Humidification or Dehumidification Calls is not an option when you select ASHRAE is Priority at ISU 1012.

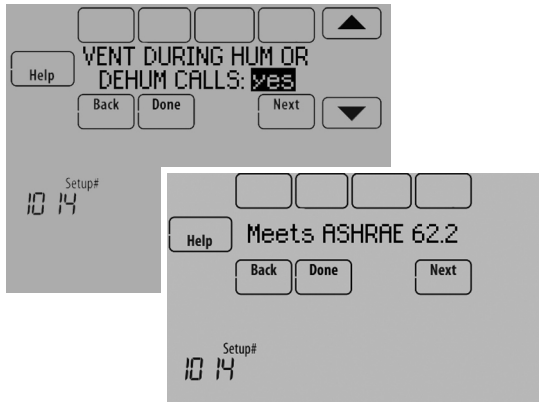

Fig. 168.

11. Select whether to Ventilate on High Indoor Humidity. See "Ventilate on High Indoor Humidity (ISU 1016)" on page 68 for more information. See Fig. 169.



Fig. 169.

Control Ventilation Level

1. Touch MENU, and select Ventilation.

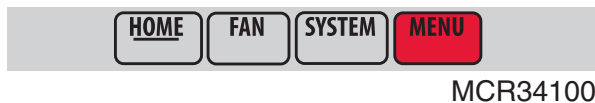

MCR34100

Fig. 170.



MCR34132

Fig. 171.

2. Select Mode, Temporary Boost, or Lockout, then select appropriate options.

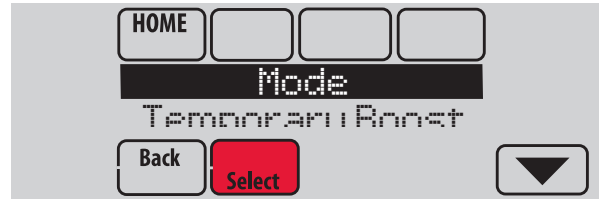

MCR34133

Fig. 172.

3. Touch Done to save your settings. Touch Cancel to ignore changes.



MCR34134

Fig. 173.

Ventilation Options

Mode:

Auto: Ventilation runs as programmed by the installer.

Off: Ventilation remains off unless turned on using the timer.

On: Ventilation is always on.



MCR34135

Fig. 174.

Temporary Boost: Touch ▲ or ▼ to select how long to run ventilation temporarily. To turn it off, set it to zero.



MCR34136

Fig. 175.

Lockout: Touch ▲ or ▼ to select Yes or No, then touch Next. Select Yes to prevent ventilation from running during the Sleep or Unoccupied (commercial) program periods or when outdoor conditions exceed values set by the installer.

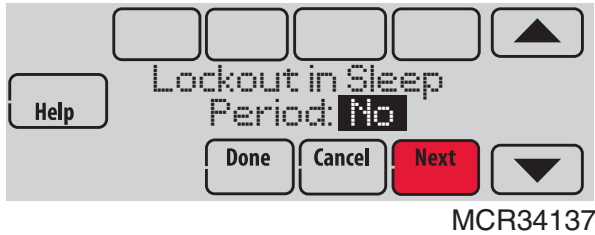

Fig. 176.

NOTE: If set up for humidification in heat mode, the ventilator will turn on to remove excess humidity if 10% or more above your humidity setting.

IAQ REMINDERS

You can set up IAQ reminders in the thermostat to remind users when filters, pads, bulbs, etc. need cleaning or replacement. The following reminders can be set:

- Air Filter 1
- Air Filter 2
- Humidifier Pad
- Humidifier Clean Tank / Water Filter
- Dehumidifier Filter
- Ventilator Core
- Ventilator Filter
- Electronic Air Cleaner Pre-Filter
- Electronic Air Cleaner Cells
- Electronic Air Cleaner Post-Filter
- UV Bulb 1
- UV Bulb 2

Reminders that are displayed under Preferences will change based on the IAQ equipment installed. Reminders for equipment that is already set up can be set using the steps below. Reminders for IAQ equipment that is not yet set up must be turned on from the installer setup.

NOTE: Air Filter, Humidifier Pad, Dehumidifier Filter, and Ventilator Filter are displayed under Preferences even if they have not been set up. Humidifier Pad is not displayed if a steam humidifier has been installed.

Some screens shown in this section may be different from those on the thermostat, depending on how you set up IAQ equipment.

1. Press MENU, then scroll to select Preferences.
2. Press Reminders. Fig. 177 is displayed.



Fig. 177.

3. Select the reminder you want to set.
4. Press ▲ or ▼ to set the timer length. Ranges, increments, and units will change based on the reminder.

NOTE: When set for run time days, the thermostat tracks the amount of time the fan has run and compares that time against the number of run time days selected. Fan run time is counted when there is a call for forced air heating, cooling, or fan.



Fig. 178.

5. Press Done to save the reminder.
6. Press Reset Timer when you have completed the recommended maintenance or you can extend the timer setting to turn off the alert and remind you later to do the recommended maintenance.
7. Repeat these steps for all reminders you want to set.

CUSTOMIZABLE REMINDERS

The thermostat can be set to alert the user when it is time for system maintenance or warranty renewal. You can set up to 10 total Custom Reminders on the thermostat.

Custom Reminders include:

- Service Reminder
 - **Set up for recurring or one time only.**
- Spring Service Reminder
 - **Provide an alert based on date or outdoor temperature.**
- Fall Service Reminder
 - **Provide an alert based on date or outdoor temperature.**
- Warranty Reminder
 - **Set up for recurring or one time only.**
- New Custom Reminder
 - **Enter new reminders or advertisements**
 - **Set up for recurring or one time only.**

You can change or create custom reminders in ISU 1200.



Fig. 179.

For example, to set up a Fall Service Reminder based on Outdoor Temperature:

1. Touch Press HERE to edit (see Fig. 179).
2. Select Fall Reminder and press Next.



Fig. 180.

3. Press up or down arrows until "Based on Out. Temp" is displayed, then press Next.

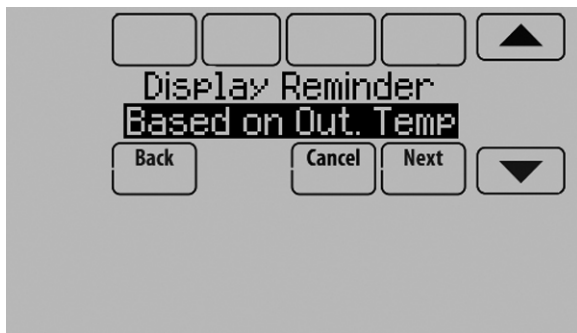

Fig. 181.

4. Press the up or down arrows to set the outdoor temperature and press Next.

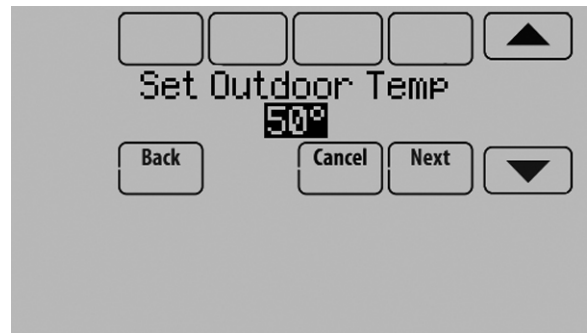

Fig. 182.

NOTE: A seasonal maintenance reminder will appear when the outdoor temperature reaches the level you select, after a specified date.

5. Press the up or down arrows to set the date to begin monitoring outdoor temperature. The thermostat will not display a reminder unless the temperature you set is reached after the date you set at this screen.



Fig. 183.

6. The preview of the Fall Service Reminder shows you what you've selected. Press Done when finished.

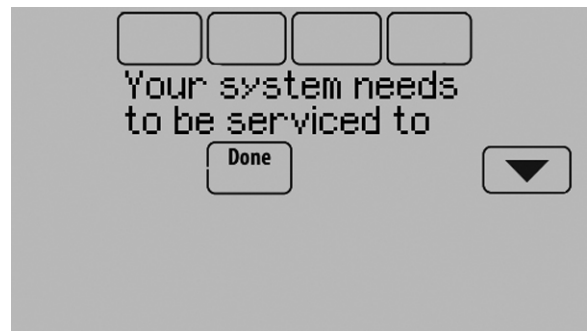

Fig. 184.

- When the user touches Press HERE for info on the Home Screen, the reminder message will be displayed.



Fig. 185.

- Pressing Select displays options for addressing the Fall Service Reminder message:
 - View More Info
 - Remind Me Later
 - Dismiss
 - View Dealer Info



Fig. 186.

- Selecting View More Info displays the Fall Service Reminder message.

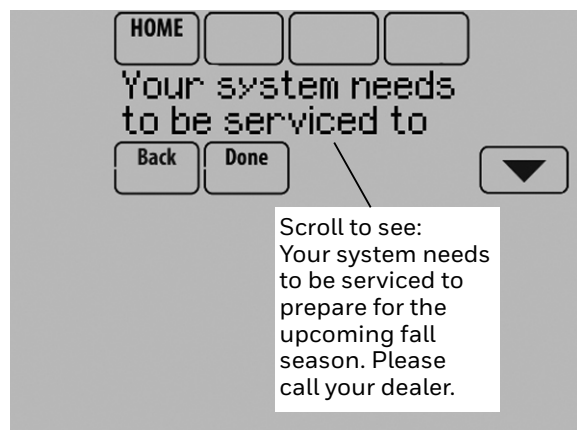

Fig. 187.

- To clear the Alert, (and turn off the Red Alert Light on the thermostat), select Dismiss.

To create a new custom reminder:

- Touch Press HERE to edit at ISU 1200 (see Fig. 179).
- Press up or down arrows until Custom Reminder is displayed, then press Next (Fig. 188).



Fig. 188.

- Touch Press HERE to edit to set the name of the reminder (Fig. 189).



Fig. 189.

- Use the arrows, Delete, and Space buttons to enter the name of the reminder, and press Done.

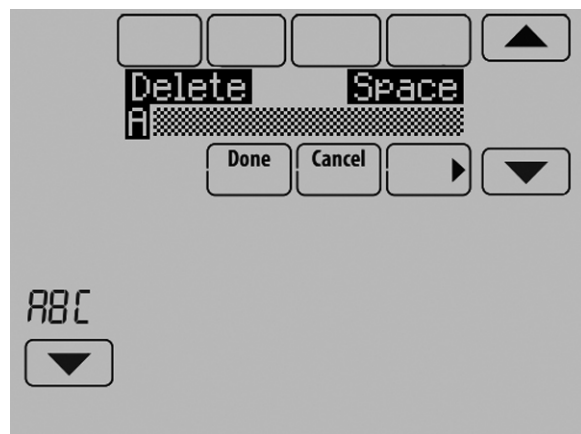

Fig. 190.

5. Touch Press HERE to edit to set the reminder message (see Fig. 191).



Fig. 191.

6. Use the arrows, Delete, and Space buttons to enter the reminder message, and press Done.

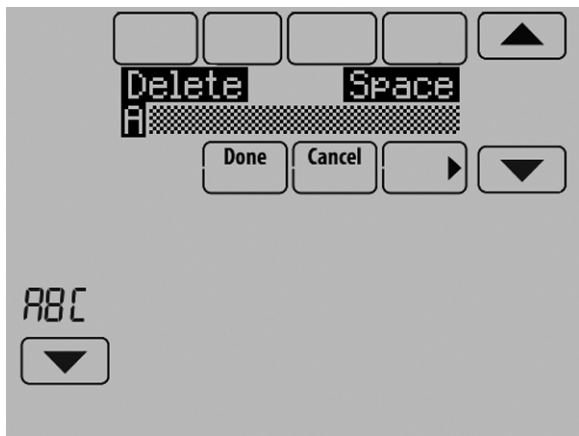

Fig. 192.

7. Press the up or down arrows to set the date when the New Custom Reminder should appear, and press Next.



Fig. 193.

8. Select whether you want the reminder to appear only once or to be recurring, and press Next.



Fig. 194.

9. If Recurring, select how often you want the reminder to appear and press Next.



Fig. 195.

10. The preview of the custom reminder shows you what you've selected.
11. The New Custom Reminder will look like this on the Home Screen:



Fig. 196.

- 12.** When the user touches Press HERE for info on the Home Screen, the reminder message will be displayed:



Fig. 197.

- 13.** Pressing Select displays options for addressing the Custom Reminder message:
- View More Info
 - Remind Me Later

- Dismiss
- View Dealer Info

- 14.** Selecting View More Info displays the Custom Reminder message.

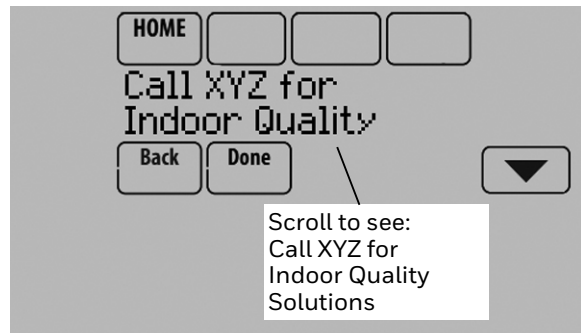

Fig. 198.

- 15.** To clear the Alert (and turn off the red alert light on the thermostat), select Dismiss.

COMMERCIAL FEATURES

The thermostat can be setup for residential or light commercial applications (ISU 101). When the thermostat is setup for commercial, the thermostat meets commercial code, Title 24 and provides the following features:

- Commercial language (occupied and unoccupied)
- Temporary override (permanent hold is not allowed)
- Temporary override duration is limited to the amount set by the installer
- Guide me through scheduling
- Adjustable ramp rates
- 365 holiday schedule
- Schedule up to 25 custom events
- Initiate occupancy
- Economizer or Time of Day output
- Pre-occupancy purge
- Additional dehumidification control options

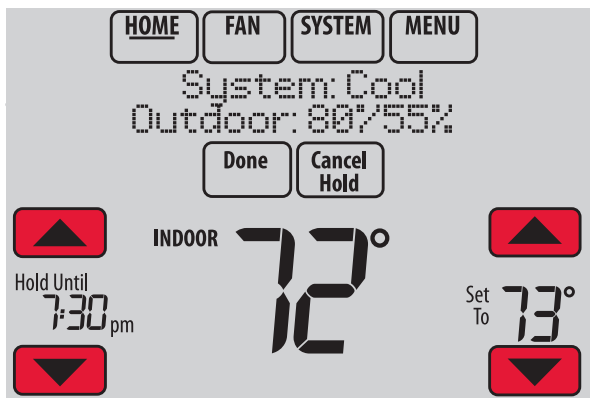

Fig. 199.

Overriding Schedules: Commercial Use

Touch ▲ or ▼ to adjust the temperature. It will be maintained until the hold time you set.

- To change the hold time, touch the Hold Until arrow buttons. This time can be adjusted up to the maximum time set by the installer.



MCR34169

Fig. 200.

- Touch Override to use a pre-set occupied temperature if a person uses the room during an unoccupied period. The new temperature will be maintained for 1 hour and can be adjusted up to the maximum time set by the installer.

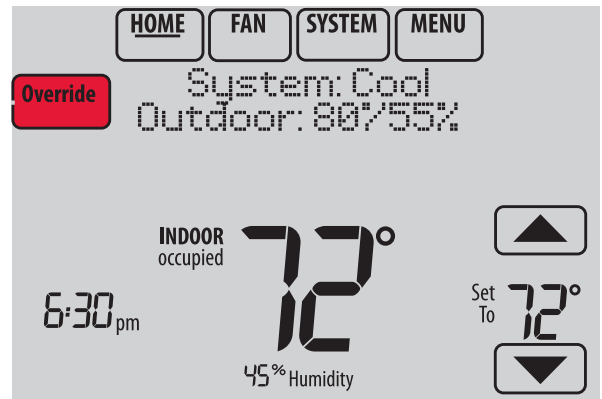

MCR34106

Fig. 201.

The programmed schedule will resume when the override timer expires. Touch Cancel Hold at any time to resume the program schedule.

Setting Holiday/Event Schedules: Commercial Use

This feature helps you conserve energy when the workplace is unoccupied for special events and holidays.

1. Touch MENU.



MCR34100

Fig. 202.

2. Select Holiday Schedule.



MCR34113

Fig. 203.

3. Select the item you want to schedule and touch Next for further scheduling details.
 - US and Canadian Holiday options let you select from a list of holidays commonly observed in each country.
 - Custom Events lets you set up other days for special schedules.



MCR34114

Fig. 204.



MCR34117

Fig. 207.

4. Make selections as prompted on each screen. For more information, see next two pages.
5. Touch Done to save your settings.

4. Review the settings and touch Done to save them. Touch Cancel to ignore the changes.

Setting Custom Events: Commercial Use

This feature lets you customize temperature settings to be maintained during a specific event. You can set up an event for a specific date or day in a month. The thermostat resumes normal scheduling after the event. The thermostat can be scheduled for up to 25 Custom Events.

1. Select Custom Events from the Holiday Schedule menu.

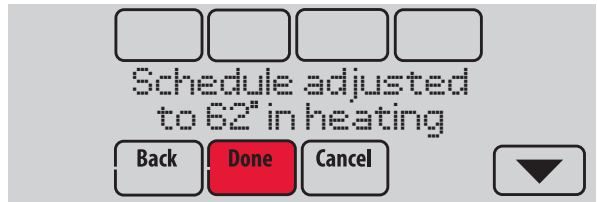

MCR34118

Fig. 208.

Setting Holiday Schedule: Commercial Use

This feature lets you customize temperature settings to be maintained on specified national holidays. The thermostat resumes normal scheduling between selected holidays.

1. Select US Holidays or Canadian Holidays from the Holiday Schedule menu.
2. Select Add/Edit Holidays. A list of national holidays is displayed.



MCR34114

Fig. 205.

2. Select Create New Event.



MCR34116

Fig. 206.

3. Select Specific Date or Month/Weekday.
 - For Specific Date, you are prompted to select the event's start date, settings, end date, and frequency.
 - For Month/Weekday, you are prompted to select the month, day of the week, week of the month, settings, length of event, and frequency for the event.

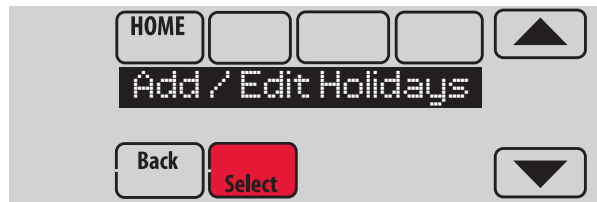

MCR34119

Fig. 209.

3. Touch the check box next to each holiday for which you want to maintain specific settings, (Touch ▲ or ▼ to scroll through the holiday list.) then touch Next.

Set the holiday schedule for Occupied or Unoccupied temperatures, depending whether the building will be in use.

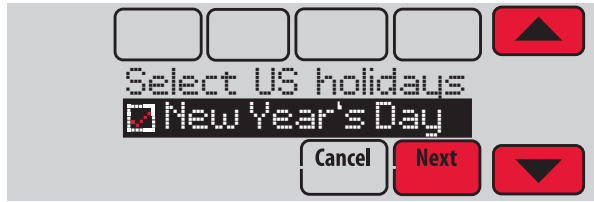

MCR34120

Fig. 210.

4. Touch ▲ or ▼ to select the Heat and Cool temperatures.

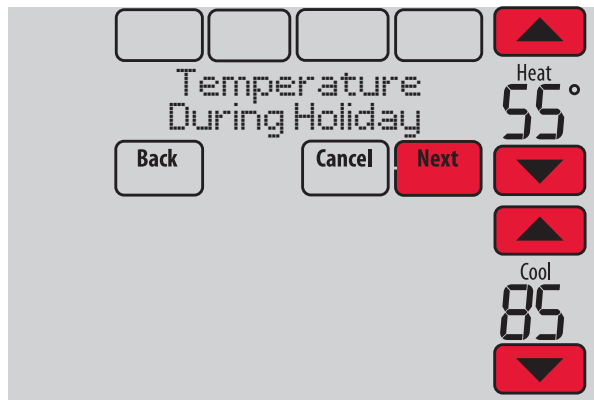

MCR34121

Fig. 211.

5. Review the settings and touch Done to save them. Touch Cancel to ignore changes.

Setting Holiday Override: Commercial Use

This feature lets you customize temperature settings to be maintained from now until a specified date. The thermostat resumes normal scheduling on the date you select.

1. Touch MENU.



MCR34100

Fig. 212.

2. Select Holiday Mode to display Temperature While Away.



MCR34122

Fig. 213.

3. Touch ▲ or ▼ to select the Heat and Cool temperatures, then touch Next to select return date.

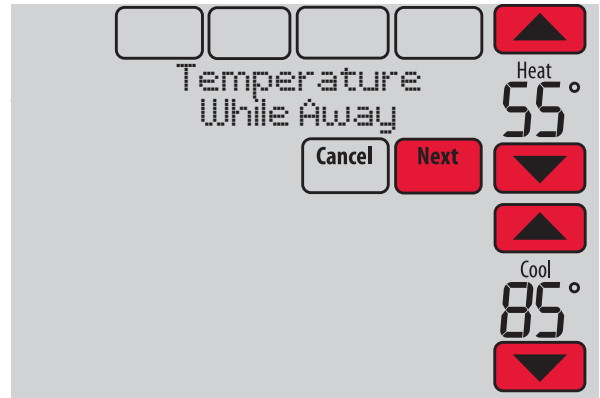

MCR34123

Fig. 214.

4. Review the settings and touch Done to save them. Touch Cancel to ignore the changes.

NOTE: The cool temperature can only be set higher than the unoccupied program setting and the heat temperature can only be set lower than the unoccupied program setting.

Initiating Occupancy Mode: Commercial Use

This feature keeps temperature at an energy saving level until you touch Press HERE to Start Occupancy. When you arrive, touch the message to maintain a comfortable temperature while the room is occupied.

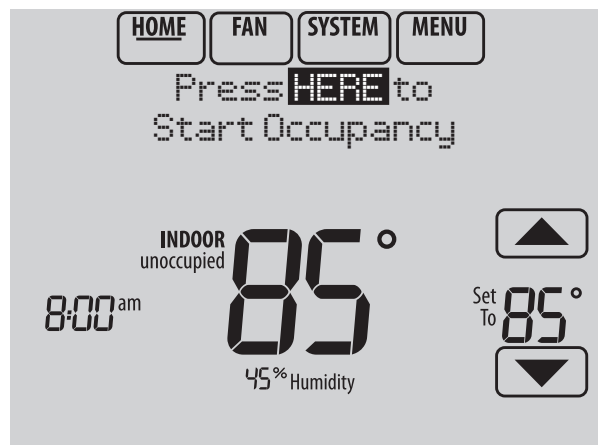

M34127

Fig. 215.

Touch the ▲ or ▼ buttons to set the temperature or the Hold Until time. The temperature is maintained until the time you set. Temperature returns to an energy-saving level after the timer expires, or the "Occupied" period ends.

NOTE: This feature is available only when programmed by the installer.

Ramp Rates (Commercial Use)

When the ramp rate is set to Off, the thermostat begins recovery at the scheduled time.

When a ramp rate is set, recovery begins early to reach the setpoint by the program time. Based on your recovery ramp setting and how far the thermostat is set back, the thermostat determines how early to turn on the system.

If an outdoor sensor is installed, you can set outdoor temperatures for mild, cold and hot days in your region. By setting these outdoor temperatures, the thermostat will automatically adjust the ramp rate based on outdoor conditions. This allows the thermostat to save energy by starting recovery at the optimum time as outdoor conditions change.

NOTE: The thermostat uses an adjustable ramp rate when the thermostat is setup for commercial. This allows the thermostat to recover on time during changing conditions (occupancy changes, temperature overrides, load conditions, opening/closing of doors etc) which are common in commercial applications.

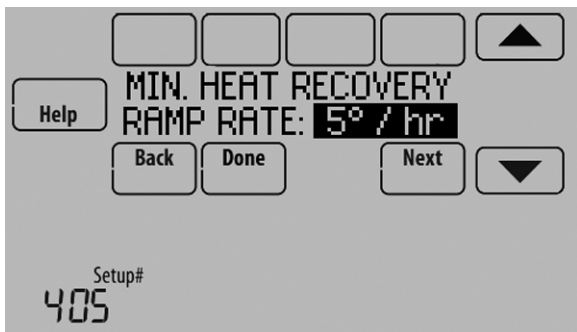

Fig. 216.

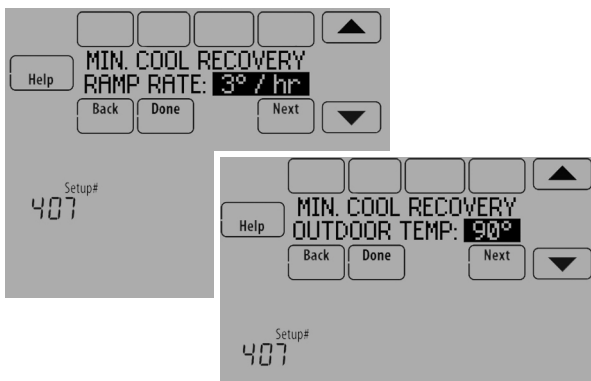

Fig. 217.

Economizer and Time of Day (TOD) Operation

Economizer

The thermostat controls an economizer module to provide ventilation during occupied periods and free cooling when outdoor conditions are favorable. In some climates the cooling system may run several hours when it may not be required to maintain indoor comfort. When outdoor conditions are favorable, ventilation with outdoor air can achieve the same level of comfort at lower cost. Table 5 explains how the Economizer Module is controlled by the thermostat.

The thermostat works with the W7220, W7212, W7213 and W7214 Economizer Modules for both heat pump and conventional systems.

Table 5. Economizer Operation.

Thermostat Mode	Equipment Operation	A-L/A Terminal or U1 Contacts. *
Occupied	Heat/Cool/Fan running	A-L/A energized or U1 contacts closed. *
Occupied temporarily	Heat/Cool/Fan running	
Occupied	Heat/Cool/Fan NOT running	
Occupied temporarily	Heat/Cool/Fan NOT running	
Pre-occupancy purge	Fan running	
Unoccupied	Cooling system running	
Unoccupied temporarily	Cooling system running	
Standby	Cooling system running	A-L/A NOT energized or U1 contacts open. *
Unoccupied	Cooling system NOT running	
Unoccupied temporarily	Cooling system NOT running	
Standby	Cooling system NOT running	A-L/A energized or U1 contacts closed. *
Non-programmable	Fan running	A-L/A NOT energized or U1 contacts open. *
Non-programmable	Fan NOT running	

* If ISU 222 “Economizer fault FDD” is set to “no” then the A-L/A is used for economizer control. If ISU 222 “Economizer fault FDD” is set to “yes” then the U1 contacts are used for economizer control.

Time of Day (TOD)

The thermostat can be set up for a Time of Day output in the installer setup. This output is commonly used to control lighting panels, turning them on for occupied periods and off for unoccupied periods. Table 6 explains how the TOD feature works with various thermostat modes.

Table 6. TOD Operation.

Thermostat Mode	A-L/A Terminal or U Contacts. *
Occupied	A-L/A energized or U contacts closed. *
Occupied temporarily	
Temperature overrides	
Unoccupied	A-L/A NOT energized or U contacts open. *
Unoccupied temporarily	
Standby	
Non-programmable	

* If ISU 222 “Economizer fault FDD” is set to “no” then the A-L/A is used for TOD control. If ISU 222 “Economizer fault FDD” is set to “yes” then the U1 contacts are used for TOD control.

The Economizer Module and Time of Day output connect to the A-L/A terminal at the thermostat and are set up at ISU 222.



Fig. 218.

Pre-Occupancy Purge

The thermostat can be set up for Pre-Occupancy Purge in the installer setup (ISU 401). When setup for Pre-Occupancy Purge, the thermostat runs the fan 1 to 3 hours before each occupied period to provide a comfortable workplace upon arrival. Options are Off and 1 to 3 hours.

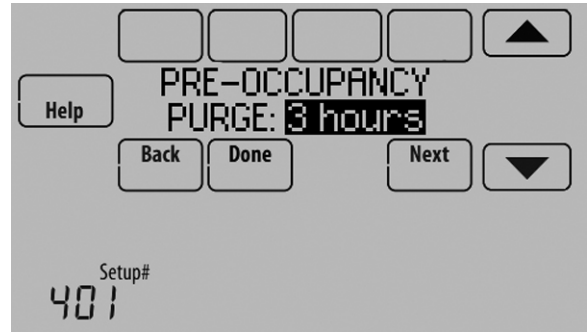

Fig. 219.

WIRED INDOOR SENSORS

For wiring, see “Wiring guide – Wired Indoor Sensors” on page 89.

Indoor Sensor Operation

Temperature Control

The thermostat can be set to respond to its internal temperature sensor, or to an optional wired indoor sensor. If multiple sensors are used, the thermostat will average the temperature detected at each sensor.

In Fig. 220, both the thermostat internal sensor and wired indoor sensor are being used for Temperature Control and are being averaged since both sensors are set to “Yes.” Select “No” if you do NOT want a specific sensor to be used for temperature control or be part of the temperature average.

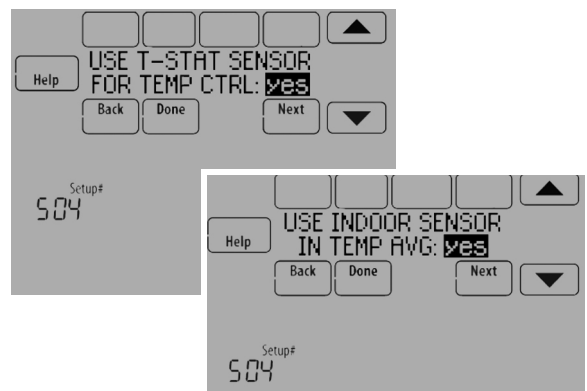

Fig. 220.

Temperature Display

The temperature reading displayed on the home screen is from the sensor or sensors that are being used for temperature control.

In Fig. 221, the temperature reading is the average of the thermostat internal sensor and the indoor sensor.

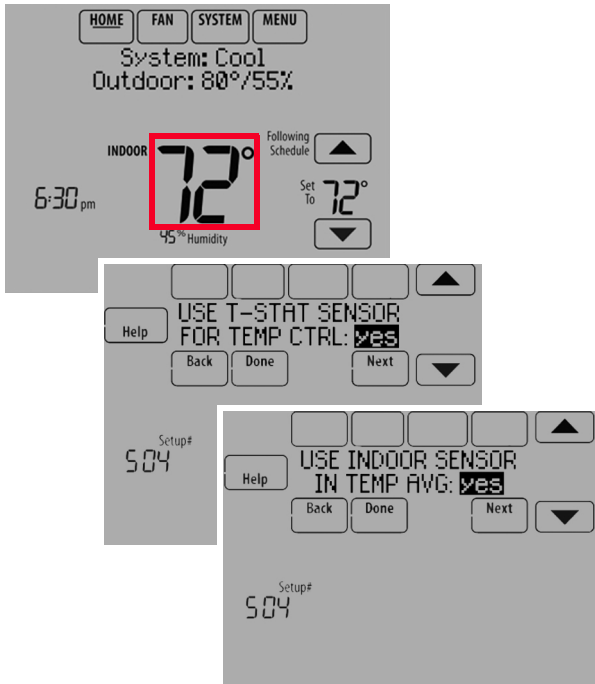

Fig. 221.

Calibration - Outdoor Sensor

The C7089U1006 Outdoor Sensor is calibrated at the factory and cannot be recalibrated in the field.

Table 7. C7089U1006 Sensor Resistance at Outdoor Temperature.

Outdoor Temperature		Ohms of Resistance	Outdoor Temperature		Ohms of Resistance
°F	°C		°F	°C	
-20	-28.9	106926	52	11.1	17136
-18	-27.8	100923	54	12.2	16387
-16	-26.7	95310	56	13.3	15675
-14	-25.6	90058	58	14.4	14999
-12	-24.4	85124	60	15.6	14356
-10	-23.3	80485	62	16.7	13743
-8	-22.2	76137	64	17.8	13161
-6	-21.1	72060	66	18.9	12607
-4	-20.0	68237	68	20.0	12081
-2	-18.9	64631	70	21.1	11578
0	-17.8	61246	72	22.2	11100
2	-16.7	58066	74	23.3	10644
4	-15.6	55077	76	24.4	10210
6	-14.4	53358	78	25.6	9795
8	-13.3	49598	80	26.7	9398
10	-12.2	47092	82	27.8	9020
12	-11.1	44732	84	28.9	8659
14	-10.0	42506	86	30.0	8315
16	-8.9	40394	88	31.1	7986
18	-7.8	38400	90	32.2	7672
20	-6.7	36519	92	33.3	7372
22	-5.6	34743	94	34.4	7086
24	-4.4	33063	96	35.6	6813
26	-3.3	31475	98	36.7	6551
28	-2.2	29975	100	37.8	6301
30	-1.1	28558	102	38.9	6062
32	0.0	27219	104	40.0	5834

Table 7. C7089U1006 Sensor Resistance at Outdoor Temperature. (Continued)

Outdoor Temperature		Ohms of Resistance	Outdoor Temperature		Ohms of Resistance
°F	°C		°F	°C	
34	1.1	25949	106	41.1	5614
36	2.2	24749	108	42.2	5404
38	3.3	23613	110	43.3	5203
40	4.4	22537	112	44.4	5010
42	5.6	21516	114	45.6	4826
44	6.7	20546	116	46.7	4649
46	7.8	19626	118	47.8	4479
48	8.9	18754	120	48.9	4317
50	10.0	17926			—

Calibration - Indoor Sensor

The C7189U1005 Wall Mount Temperature Sensor is calibrated at the factory and cannot be recalibrated in the field.

Table 8. C7189U1005 Sensor Resistance at Room Temperature.

Room Temperature		Ohms of Resistance	Room Temperature		Ohms of Resistance
°F	°C		°F	°C	
40	4.4	22537	72	22.2	11100
42	5.6	21516	74	23.3	10644
44	6.7	20546	76	24.4	10210
46	7.8	19626	78	25.6	9795
48	8.9	18754	80	26.7	9398
50	10.0	17926	82	27.8	9020
52	11.1	17136	84	28.9	8659
54	12.2	16387	86	30.0	8315
56	13.3	15675	88	31.1	7986
58	14.4	14999	90	32.2	7672
60	15.6	14356	92	33.3	7372
62	16.7	13743	94	34.4	7086

WIRING

Table 9. Thermostat Terminal Designation Descriptions.

Conventional System		Heat Pump	
Terminal	Description	Terminal	Description
C	Common wire from secondary side of cooling transformer (if 2 transformers).	C	Common wire from secondary side of cooling transformer.
Rc*	Cooling power	Rc	Cooling power
R*	Heating power	R	Heating power
W	Heat Stage 1	O / B	Changeover valve for heat pumps
W2	Heat Stage 2	AUX-E	Backup Heat/Emergency Heat
Y	Compressor Stage 1	Y	Compressor Stage 1
Y2	Compressor Stage 2	Y2	Compressor Stage 2
G	Fan Relay	G	Fan Relay
A	Connect to Economizer Module or Lighting Panel (TOD).	L / A	Connect to Compressor Monitor, Zone Panel, Economizer Module or Lighting Panel (TOD).
U1 / U1	Universal relay for humidification, dehumidification, ventilation, economizer control, with fault, or a stage of heating/cooling.	U1 / U1	Universal relay for humidification, dehumidification, ventilation, economizer control, with fault, or a stage of heating/cooling.
S1 / S1	Universal input for a wired indoor, outdoor or discharge sensor.	S1 / S1	Universal input for a wired indoor, outdoor or discharge sensor.
K†	Connect to K on Wire Saver module.	K†	Connect to K on Wire Saver module.

* Remove factory installed jumper for two transformer systems.

† The THP9045A1023 Wire Saver module is used on heat/cool systems when you only have four wires at the thermostat and you would like the thermostat to be powered with a common wire. Use the K terminal in place of the Y and G terminals on conventional or heat pump systems to provide control of the fan and the compressor through a single wire—the unused wire then becomes your common wire. See page 85 and the THP9045 instructions (form 69-2065EFS) for more information.

CAUTION
Electrical Hazard.
Can cause electrical shock or equipment damage.
 Disconnect power before wiring.

All wiring must comply with local electrical codes and ordinances. See Fig. 225–234.

1. Select wiring diagram that corresponds with system type and the equipment being installed.
2. Loosen the screws for the appropriate terminals. Insert wires in the terminal block under the loosened screw. See Fig. 222.
3. Securely tighten each screw.
4. Push excess wire back into the hole.
5. Plug the hole with nonflammable insulation to prevent drafts from affecting the thermostat.
6. See Fig. 225–234 for typical wiring hookups.

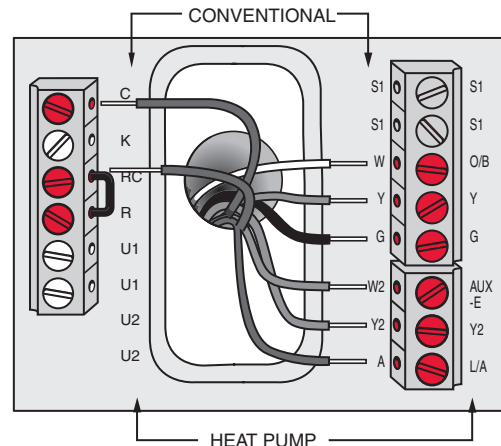

Fig. 222. Inserting wires in thermostat terminal block.

IMPORTANT

Use 18–22 gauge thermostat wire.

Wiring with the THP9045 Wiring Module (Wire Saver)

The THP9045 Wiring Module is designed to be used with applicable thermostats in which a 24V common is required and there are not enough wires. The K terminal on the thermostat can be used to operate both the fan and compressor on a single wire, and the module is designed to receive the signal from the K terminal, split that signal and re-route it to operate the compressor and/or fan for normal operation. See form 69-2065EFS for additional information.

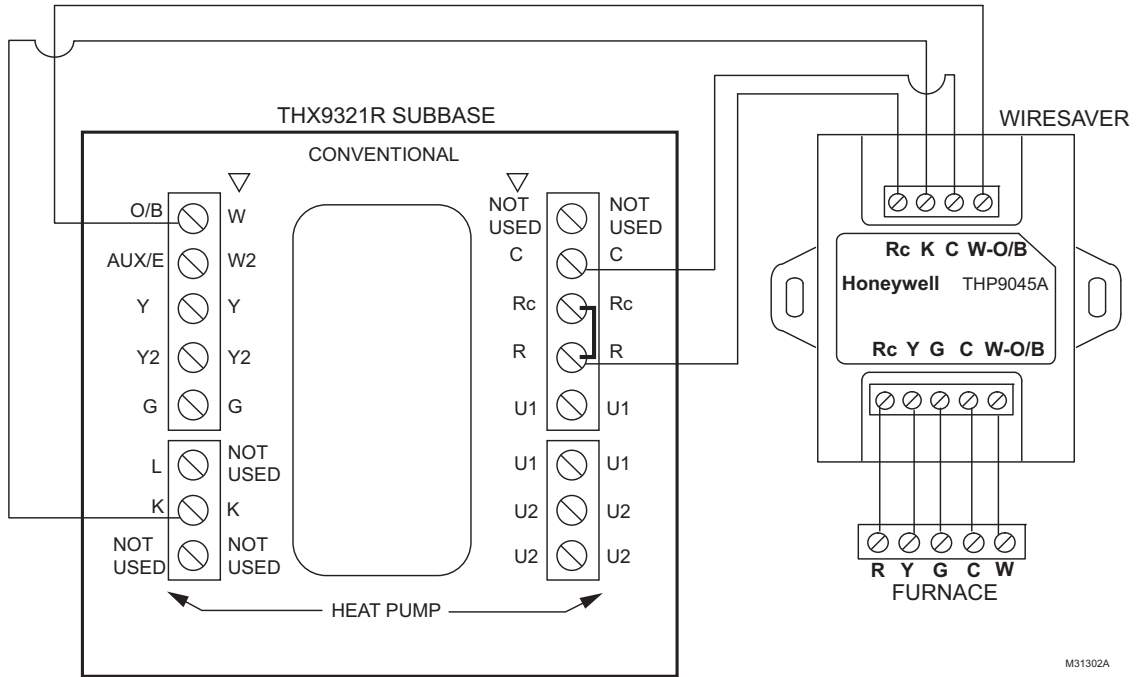

M31302A

Fig. 223. Example Wire Saver wiring diagram for 1H/1C conventional application.

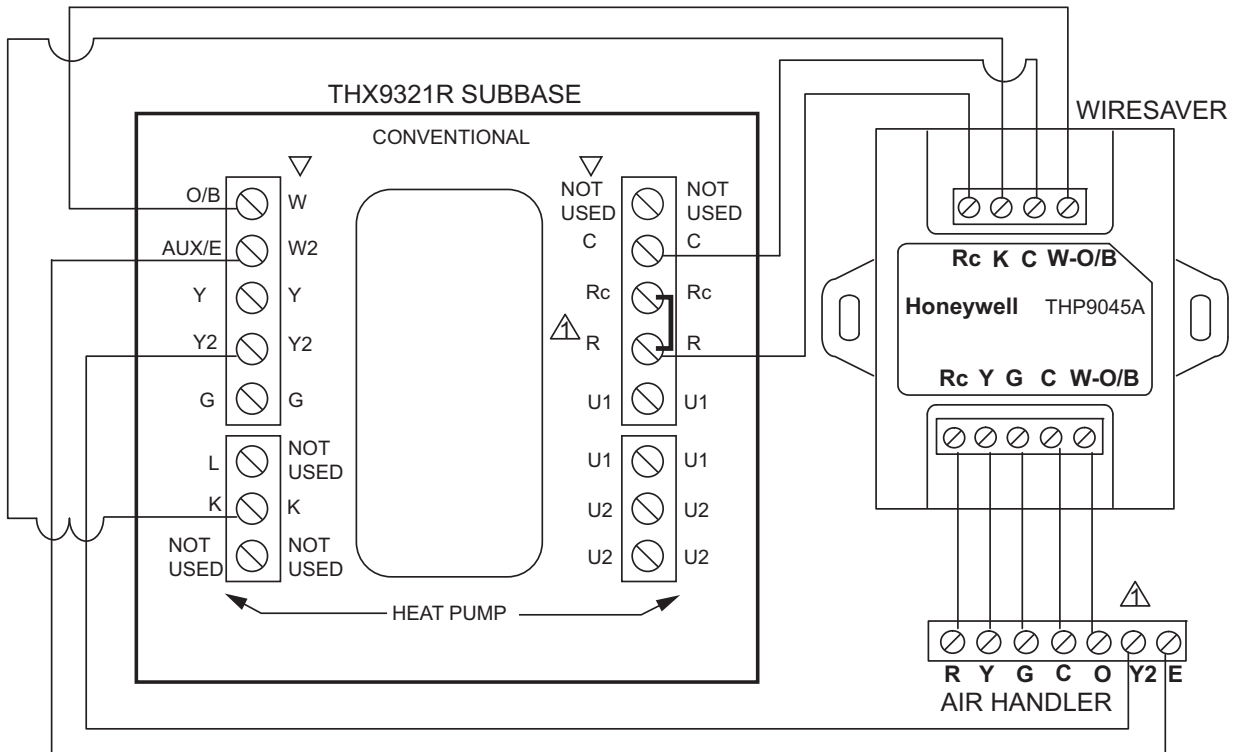

⚠ MATCH THE WIRES FROM THE HEAT PUMP TO THE AIR HANDLER AS NORMAL.

M31304A

Fig. 224. Example Wire Saver wiring diagram for a 3H/2C heat pump application.

Wiring IAQ Equipment or a Heat/Cool Stage to the Universal Terminals To Thermostat

“U” terminals can be used for humidification, dehumidification, ventilation or a stage of heating/cooling.

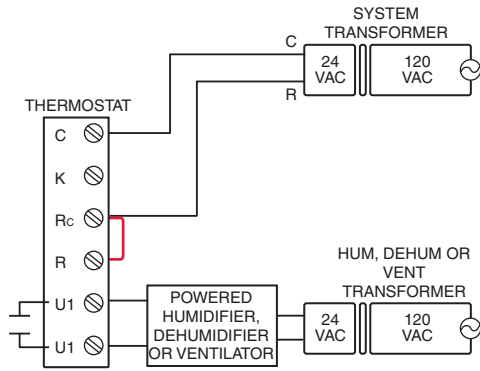

Fig. 225. Wiring a powered humidifier, dehumidifier, or ventilator.

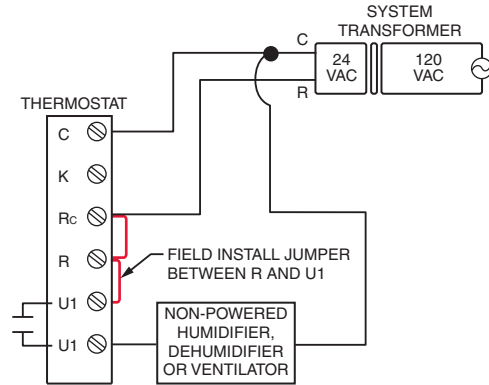

Fig. 227. Wiring a non-powered humidifier, dehumidifier, or ventilator.

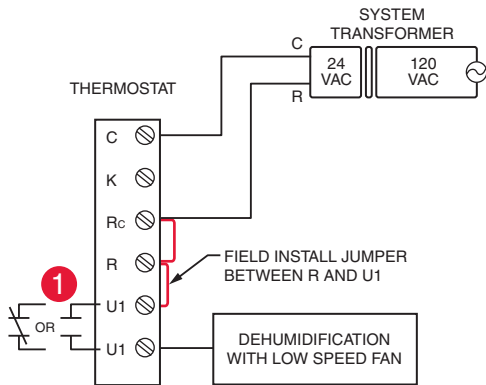



Fig. 226. Dehumidification with low speed fan using a variable speed blower.

1 Wire the thermostat universal relay to the low speed fan for dehumidification control at the equipment. The thermostat relay can be set to normally open or normally closed in the thermostat installer setup.

-  Normally open, dry contacts
-  Normally closed, dry contacts

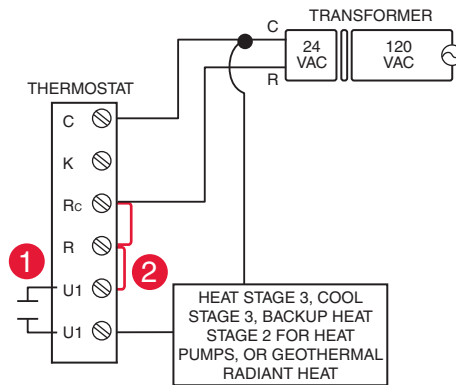

Fig. 228. Wiring a heat or cool stage to U1.

1 U1 terminals are normally open dry contacts when set up for a stage of heating or cooling.
 2 You must install a field jumper if the stage of heating or cooling is powered by system transformer. Do NOT install a field jumper if the stage of heating has its own transformer.

Wiring Economizer Control

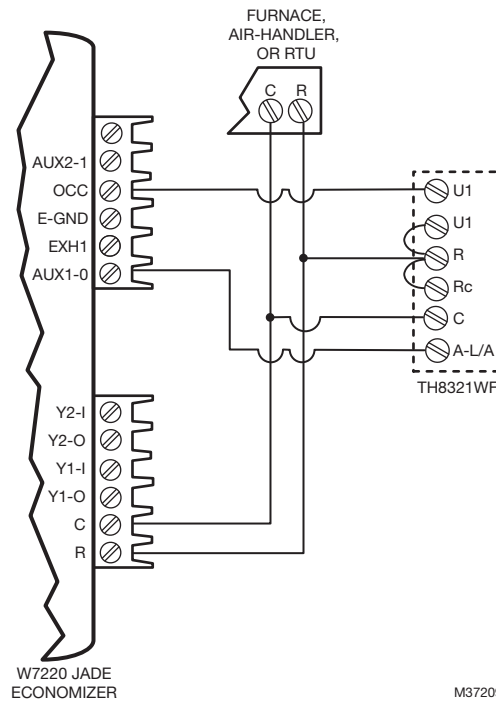

Fig. 229. Economizer control with economizer fault alert using TH8321WF.

NOTES: Configure the TH8321WF to control economizer (see settings for ISU 222).

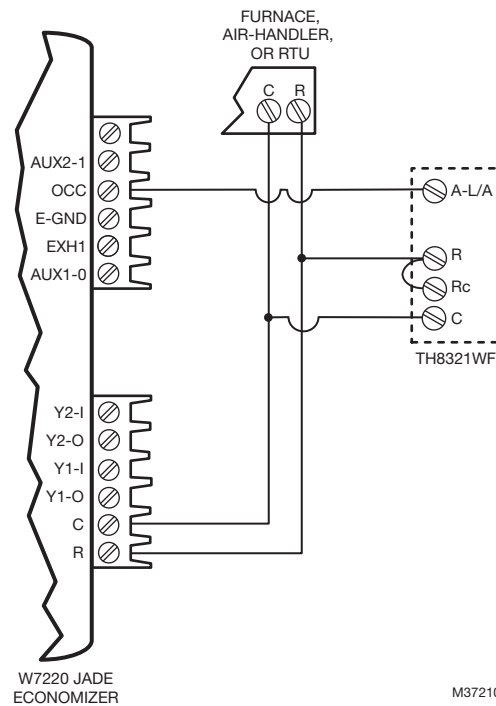

Fig. 230. Economizer control without economizer fault alert using TH8321WF.

NOTE: Configure the TH8321WF to control economizer (see settings for ISU 222).

Wiring C7089U1006 Outdoor Sensor



CAUTION

Electrical Interference (Noise) Hazard.
Can cause erratic system operation.

Keep wiring at least one foot away from large inductive loads such as motors, line starters, lighting ballasts and large power distribution panels.

Use shielded cable to reduce interference when rerouting is not possible.

IMPORTANT

Erratic temperature readings from a sensor can occur as a result of any of the wiring practices described below. Avoid these practices to assure correct operation. Use shielded cable to reduce interference if rerouting sensor wiring is not possible.

- Be sure wires have a cable separate from the thermostat cable.
- Do not route temperature sensor wiring with building power wiring, next to control contactors or near light dimming circuits, electric motors or welding equipment.
- Avoid poor wiring connections.
- Avoid intermittent or missing building earth ground.



CAUTION

Electrical Shock Hazard.

Can cause electrical shock or equipment damage.

Disconnect power supply before connecting wiring.

Wiring must comply with applicable codes, ordinances and regulations:

1. Wire C7089U1006 Outdoor Sensor to S terminals on the thermostat. If leadwire provided is not long enough (60 in.), run a cable to a hole at C7089U1006 location.
 - a. Using color-coded, 18-gauge thermostat wire is recommended.
 - b. Pigtail wiring can be used.
2. Mount C7089U1006 in its mounting clip.
3. Plug wiring hole using nonhardening caulk or putty.

Wiring guide – Wired Indoor Sensors



CAUTION

Electrical Interference (Noise) Hazard.
Can cause erratic system operation.

Keep wiring at least one foot away from large inductive loads such as motors, line starters, lighting ballasts and large power distribution panels.

Use shielded cable to reduce interference when rerouting is not possible.

IMPORTANT

Erratic temperature readings from a sensor can occur as a result of any of the wiring practices described below. Avoid these practices to assure correct operation. Use shielded cable to reduce interference if rerouting sensor wiring is not possible.

- Be sure wires have a cable separate from the thermostat cable.
- Do not route temperature sensor wiring with building power wiring, next to control contactors or near light dimming circuits, electric motors or welding equipment.
- Avoid poor wiring connections.
- Avoid intermittent or missing building earth ground.



CAUTION

Electrical Shock Hazard.
Can cause electrical shock or equipment damage.
Disconnect power supply before connecting wiring.

Use the S1 terminal for wired sensors.

Wiring 4 C7189U1005 sensors (10k ohm) for temperature averaging network. Select 10K in the Installer Setup (ISU 503) when using C7189U1005 sensor(s).

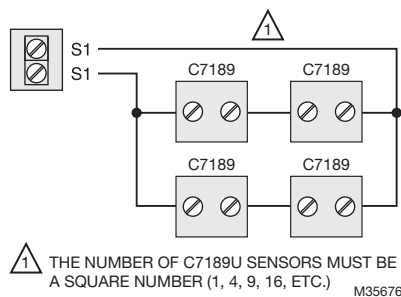

Fig. 231. Wiring 4 C7189U sensors.

Wiring 2 TR21 sensors (20k ohm) and 1 TR21-A sensor (10k ohm) for temperature averaging network. Select 20K in the Installer Setup (ISU 503) when using 2 TR21 sensors and 1 TR21-A sensor.

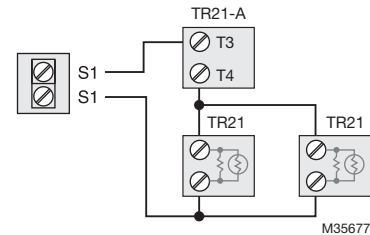

Fig. 232. Wiring 2 TR21 sensors and 1 TR21-A sensor.

Wiring 4 TR21 sensors (20k ohm). Select 20K in the Installer Setup (ISU 503) when using TR21 sensor(s).

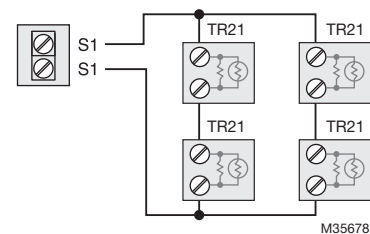

Fig. 233. Wiring 4 TR21 sensors.

Wiring 2 TR21-A sensors (10k ohm) for temperature averaging network. Select 20K in the Installer Setup (ISU 503) when using 2 TR21-A sensors in series. Note: The TR21-A sensor must be used in combination with TR21 or TR21-A sensor.

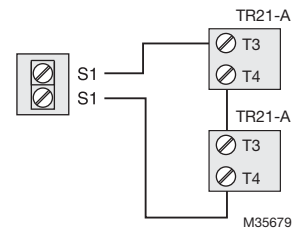

Fig. 234. Wiring 2 TR21-A sensors.

TROUBLESHOOTING

Table 10. Troubleshooting.

Symptom	Action
Screen is blank	<ul style="list-style-type: none"> • Check circuit breaker and reset if necessary. • Make sure power switch at heating and cooling system is on. • Make sure furnace door is closed securely.
Screen is difficult to read	<ul style="list-style-type: none"> • Change screen brightness using Preferences menu.
Red light is on	<ul style="list-style-type: none"> • If thermostat is in Emergency Heat mode, the red light is normal. It shows that the thermostat is in Emergency Heat mode. • If thermostat is not in Emergency Heat mode, an alert is active. Check message on the thermostat screen.
Heating or cooling system does not respond	<ul style="list-style-type: none"> • Touch SYSTEM to set system to Heat. Make sure the temperature is set higher than the Inside temperature. • Touch SYSTEM to set system to Cool. Make sure the temperature is set lower than the Inside temperature. • Check circuit breaker and reset if necessary. • Make sure power switch at heating & cooling system is on. • Make sure furnace door is closed securely. • If “Wait” is displayed, the compressor protection timer is on. Wait 5 minutes for the system to restart safely, without damaging the compressor.

REGULATORY INFORMATION

FCC Compliance Statement

§ 15.19 (A)(3) (USA ONLY)

This device complies with part 15 of the FCC Rules.

Operation is subject to the following two conditions:

1. This device may not cause harmful interference, and
2. this device must accept any interference received, including interference that may cause undesired operation.

FCC WARNING

(PART 15.21) (USA ONLY)

Changes or modifications not expressly approved by the party responsible for compliance could void the user's authority to operate the equipment.

FCC INTERFERENCE STATEMENT

(PART 15.105 (B)) (USA ONLY)

This equipment has been tested and found to comply with the limits for a Class B digital device, pursuant to Part 15 of the FCC Rules. These limits are designed to provide reasonable protection against harmful interference in a residential installation. This equipment generates uses and can radiate radio frequency energy and, if not installed and used in accordance with the instructions, may cause harmful interference to radio communications. However, there is no guarantee that interference will not occur in a particular installation. If this equipment does cause harmful interference to radio or television reception, which can be determined by turning the equipment off and on, the user is encouraged to try to correct the interference by one of the following measures:

- Reorient or relocate the receiving antenna.
- Increase the separation between the equipment and receiver.
- Connect the equipment into an outlet on a circuit different from that to which the receiver is connected.
- Consult the dealer or an experienced radio/TV technician for help.

IC Regulations

This device complies with Industry Canada's licence-exempt RSSs. Operation is subject to the following two conditions:

1. This device may not cause interference; and
2. This device must accept any interference, including interference that may cause undesired operation of the device.

VISIONPRO® 8000 WITH WI-FI®

Wi-Fi® is a registered trademark of Wi-Fi Alliance®.

Home and Building Technologies

In the U.S.:

Honeywell

715 Peachtree Street NE

Atlanta, GA 30308

customer.honeywell.com

® U.S. Registered Trademark
© 2018 Honeywell International Inc.
33-00096-03 M.S. Rev. 10-18
Printed in United States

Honeywell